

Sisteme din plastic și aluminiu pentru evacuare a gazelor arse **LISTA DE PREȚURI**

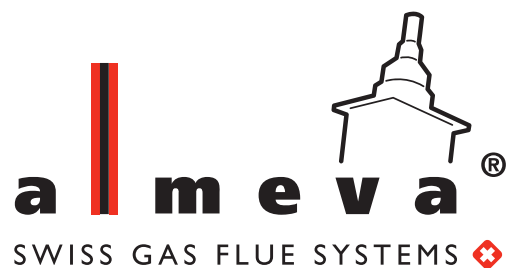

Valabil din 1.8.2022
Preț fără TVA

Designed in
Switzerland

+ Since 1994



ALMEVA EAST EUROPE a.s.

SISTEME DIN PLASTIC ȘI ALUMINIU PENTRU EVACUARE A GAZELOR ARSE

CARACTERISTICILE DE BAZĂ ALE SISTEMULUI

Avantaje

Sistem modern avansat pentru evacuare a gazelor arse care, printr-un procedeu de producție verificat de-a lungul anilor, a atins o precizie și calitate perfectă în ceea ce privește producerea gamei întregi de tuburi, piese fasonate și a celorlalte accesorii. Forma îmbinării tip mufă, proiectată cu exactitate înaltă, asigură caracteristici hidraulice excelente ale conductelor, fapt care garantează circulația perfectă a gazelor arse și un risc scăzut de blocare cu reziduri.

Îmbinările tip mufă sunt etanșate cu garniturile din elastomer care asigură sigilarea imediată excelentă, rezistență, dar și o flexibilitate pe termen lung și, spre deosebire de alte tipuri de îmbinări, accelerează și facilitează completarea sistemului, de altfel destul de complex.

Facilitatea în montajul rapid și lucrări de revizie ușoară permite companiilor care efectuează montajul o mai mare productivitate a muncii atât în cazul instalării unui coș de fum nou, cât și în cazul tubulării canalelor de aerisire sau coșurilor de fum existente.

Utilizare în funcție de tipul de cazan, combustibil și tipul canalelor de evacuare a gazelor arse:

- sistemul din plastic de evacuare a fumului servește la evacuarea gazelor arse de la cazane pe combustibil de temperatură joasă, cu temperatura maximă a gazelor arse de 120°C;
 - sistemul din aluminiu de evacuare fumului servește pentru evacuare a gazelor arse de la cazanele atmosferice de tip „TURBO” cu temperatura maximă gazelor arse de 200°C;
- sistemul din plastic de evacuare a fumului este destinat mai ales pentru canale de evacuare a gazelor cu suprapresiune și cu suprapresiune mare (presiunea în interiorul tubulaturii coșului de fum în cursul operării este mai mare decât în exterior). Se poate utiliza și pentru coșurile de fum cu tiraj natural;
- sistemul din plastic de evacuare a fumului nu este destinat pentru canale de evacuare a gazelor arse în care poate avea loc arderea funinginii;
 - sistemul din plastic de evacuare a fumului este potrivit pentru coșurile de fum planificate pentru regimul de operare umedă;
 - sistemul din plastic de evacuare a fumului este utilizabil doar pentru canalele de evacuare a gazelor arse de la cazanele pe combustibili gazeți, respectiv, gaz metan (L, H) și combustibili lichizi (LTO cu conținut de sulf $\leq 0,2\%$, petrol)

Utilizare în funcție de locul de instalare

- pentru construcții noi (montaj nou) de coșuri de fum;
- pentru tubularea coșurilor de fum existente și a canalelor de aerisire;
- posibilitatea de aplicare a sistemului aferent atât în interior, cât și în exterior.

Elementele sistemului

Sistemul de evacuare a gazelor arse Almeva dispune de o serie întreagă de componente originale ale unității moderne funcționale de evacuare a gazelor arse.

Sistemul este alcătuit din peste 200 de elemente, fiecare fiind realizat la dimensiuni diferite, iar cele peste 2250 poziții din catalog formează un sistem unitar de evacuare de gaze arse. Grație unui număr nelimitat de îmbinări ale elementelor componente, asortate perfect, Almeva oferă cel mai larg sortiment de sisteme din plastic și aluminiu pentru evacuarea fumului, asigurând calitatea garantată ale produselor sale.



MODIFICĂRI FAȚĂ DE VERSIUNEA ANTERIOARĂ A LISTEI DE PREȚURI ALMEVA 1.2.2022

A avut loc o modificare de preț.

La sistemul LIL a fost adăugată reducția centrală LPKL86

În sistemul CAS (cascadă concentrică) a fost adăugată dop cascada cu colector condens.

PENTRU CAZANELE CU CONDENSAȚIE ȘI DE TEMPERATURĂ JOASĂ

Sistem fix evacuare fum (STARR)

PPH	Componența sistemului	4
DN 60 – 315 mm	Elementele sistemului	5-11

Sistem flexibil evacuare fum (FLEX)

PPH	Componența sistemului	12
DN 60 – 200 mm	Elementele sistemului	13-16

Sistem concentric intern aer-gaze arse (LIK)

PPH/PPH	Componența sistemului	17
DN 60 / 100 și DN 80 / 125 mm	Elementele sistemului	18-21

Sistem concentric intern aer-gaze arse (LIL, LIB)

LIL – PPH/inox-komaxit alb	Componența sistemului LIL, LIB	22
LIB – PPH/inox	Elementele sistemului LIL	23-27
DN 60 / 100 – DN 200 / 300 mm	Elementele sistemului LIB	27

Sistem concentric extern aer-gaze arse (LAB)

PPH/inox	Componența sistemului	28
DN 60 / 100 – DN 200 / 300 mm	Elementele sistemului	29-31

Sistem de evacuare gaze arse independent de aerul din încăpere (LAS)

Varianta 1 – PPH	Componența sistemului – varianta 1	32
DN 80 – 315 cu racorduri 87° DN 60 și 80 mm	Elementele sistemului – varianta 1	33
Varianta 2 – PPH/inox-komaxit alb	Componența sistemului – varianta 2	34
DN 80 / 125 – 200 / 300 cu racorduri 87° DN 60 / 100 și 80 / 125 mm	Elementele sistemului – varianta 2	35
Varianta 3 – PPH/inox	Componența sistemului – varianta 3	36
DN 110 / 160 – 200 / 300 cu racorduri 87° DN 60 / 100 și 80 / 125 mm	Elementele sistemului – varianta 3	37

Sistem de evacuare gaze arse pentru cazanele racordate în cascadă (CAS)

Varianta 1 – PPH	Componența sistemului – varianta 1	38
DN 80 – 315 cu racorduri 45°, 87° DN 60 – 250 mm	Elementele sistemului – varianta 1	39-44
Varianta 2 – PPH/inox-komaxit alb	Componența sistemului – varianta 2	45
DN 110 / 160 – 200 / 300 cu racorduri 87° DN 60 / 100 – 125 / 180 mm	Elementele sistemului – varianta 2	46

PENTRU CAZANELE DE TIP „TURBO”

Sistem din aluminiu pentru evacuare a gazelor arse (AL1, AL2)

Aluminiu – komaxit alb sau nevopsit	Componența sistemului AL1	47
DN 60 – 100 mm, DN 60 / 100 și DN 80 / 125 mm	Elementele sistemului AL1 – Al monostrat	48
	Componența sistemului AL2	49
	Elementele sistemului AL2 – Al/Al concentric	50

Accesorii (ZUB)

	Listă accesorii	51
	Listă accesorii pentru sisteme din plastic	52-53
	Listă accesorii pentru sisteme din aluminiu	54
	Elemente accesorii – tehnică ancorare	55

Informații suplimentare

	CertIFICATE conformitate	56
	Declarații de performanță, etichete coșuri de fum	57
	Certificate	58-59

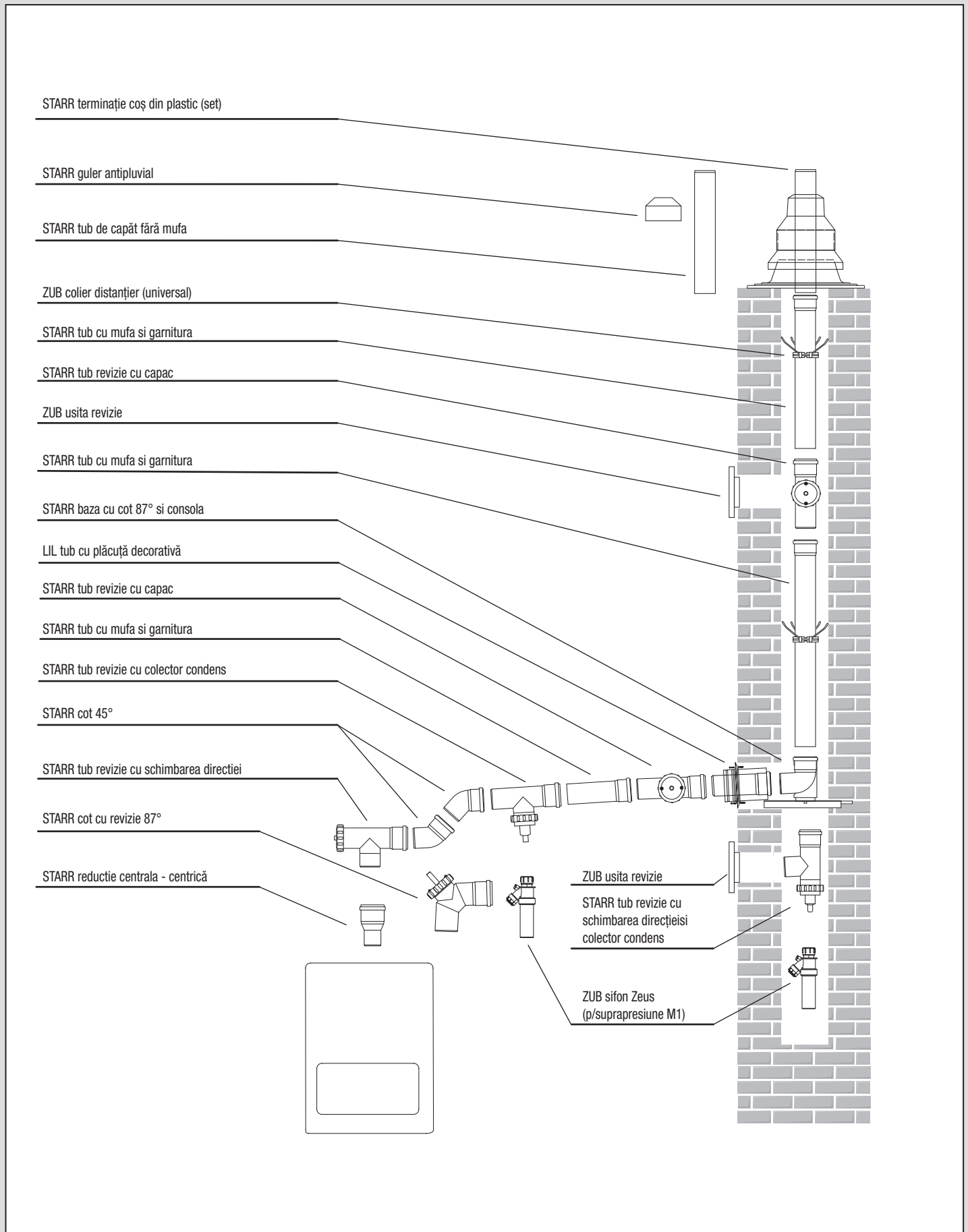

SISTEM FIX EVACUARE FUM
DN 60 – 315 mm

STARR tub cu mufa si garnitura	DN	Cod	Preț [EUR / buc]	Notă	
	0,25 m	60	PBRM05	5,70	
		80	PBRM08	6,90	
		80	PWRM08	6,90	alb
		110	PBRM01	9,50	
		125	PBRM02	12,80	
		160	PBRM06	16,70	
		200	PBRM00	45,70	
		250	PBRM0V	86,30	
		315	PBRM03	120,20	
		0,50 m	60	PBRM55	6,50
80	PBRM58		8,70		
80	PWRM58		8,70	alb	
110	PBRM51		10,60		
125	PBRM52		16,70		
160	PBRM56		23,60		
200	PBRM50		58,30		
250	PBRM5V		108,70		
1,00 m	315	PBRM53	157,50		
	60	PBRM15	9,10		
	80	PBRM18	10,20		
	80	PWRM18	10,20	alb	
	110	PBRM11	16,70		
	125	PBRM12	24,40		
	160	PBRM16	36,10		
2,00 m	200	PBRM10	70,80		
	250	PBRM1V	147,10		
	315	PBRM13	229,50		
	60	PBRM25	15,70		
	80	PBRM28	18,50		
	80	PWRM28	18,50	alb	
	110	PBRM21	25,00		
	125	PBRM22	38,70		
	160	PBRM26	61,00		
	200	PBRM20	110,40		
250	PBRM2V	222,00			
315	PBRM23	359,70			

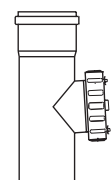
STARR tub revizie cu capac	DN	Cod	Preț [EUR / buc]	Notă
	60	PBRTD5	16,70	
	80	PBRTD8	18,10	
	80	PWRD8	18,10	alb
	110	PBRTD1	27,70	
	125	PBRTD2	60,00	
	160	PBRTD6	83,00	
	200	PBRTD0	131,00	
	250	PBRTDV	194,00	
	315	PBRTD3	212,80	

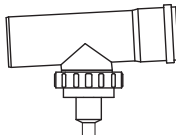
STARR tub revizie cu colector condens	DN	Cod	Preț [EUR / buc]	Notă
	60	PBRTA5	24,60	
	80	PBRTA8	25,00	
	80	PWRTA8	25,00	alb
	110	PBRTA1	28,50	
	125	PBRTA2	61,00	
	160	PBRTA6	87,10	
	200	PBRTA0	135,10	
	250	PBRTAV	197,70	
	315	PBRTA3	215,50	

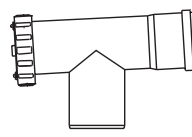
STARR tub revizie cu schimbarea direcției	DN	Cod	Preț [EUR / buc]	Notă
	60	PBUTD5	17,70	
	80	PBUTD8	28,70	
	80	PWUTD8	28,70	alb
	110	PBUTD1	35,90	
	125	PBUTD2	70,60	
	160	PBUTD6	96,30	
	200	PBUTD0	131,40	
	250	PBUTDV	202,60	
	315	PBUTD3	315,00	

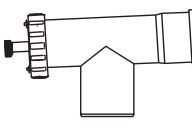
STARR tub revizie cu schimbarea direcției si vizor service	DN	Cod	Preț [EUR / buc]	Notă
	60	PBTM95	20,00	
	80	PBTM98	31,40	
	80	PWTM98	31,40	alb
	110	PBTM91	42,40	
	125	PBTM92	77,70	
	160	PBTM96	100,80	
	200	PBTM90	142,00	
	250	PBTM9V	209,10	
	315	PBTM93	331,60	

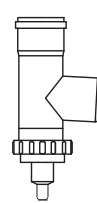
STARR tub revizie cu schimbarea direcției si colector condens	DN	Cod	Preț [EUR / buc]	Notă
	60	PBUTA5	20,80	
	80	PBUTA8	27,70	
	80	PWUTA8	27,70	alb
	110	PBUTA1	35,10	
	125	PBUTA2	68,70	
	160	PBUTA6	90,20	
	200	PBUTA0	130,60	
	250	PBUTAV	200,60	
	315	PBUTA3	315,00	

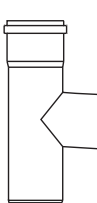
STARR tub racord	DN	Cod	Preț [EUR / buc]	Notă
	60	PBTE95	10,60	
	80	PBTE98	13,60	
	80	PWTE98	13,60	alb
	110	PBTE91	18,50	
	125	PBTE92	50,60	
	160	PBTE96	66,50	
	200	PBTE90	100,80	
	250	PBTE9V	148,50	
	315	PBTE93	257,10	

STARR cot 15°	DN	Cod	Preț [EUR / buc]	Notă
	60	PBSB15	9,10	
	80	PBSB18	9,50	
	80	PWSB18	9,50	alb
	110	PBSB11	13,60	
	125	PBSB12	28,10	
	160	PBSB16	42,40	
	200	PBSB10	65,70	
	250	PBSB1V	98,50	
	315	PBSB13	169,70	

STARR cot 30°	DN	Cod	Preț [EUR / buc]	Notă
	60	PBSB35	9,10	alb
	80	PBSB38	9,50	
	80	PWSB38	9,50	
	110	PBSB31	11,20	
	125	PBSB32	21,00	
	160	PBSB36	34,40	
	200	PBSB30	65,70	
	250	PBSB3V	98,50	
	315	PBSB33	169,70	

STARR cot 45°	DN	Cod	Preț [EUR / buc]	Notă
	60	PBSB45	6,10	alb
	80	PBSB48	6,30	
	80	PWSB48	6,30	
	110	PBSB41	9,10	
	125	PBSB42	18,90	
	160	PBSB46	27,70	
	200	PBSB40	65,70	
	250	PBSB4V	119,70	
	315	PBSB43	169,70	

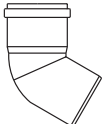
STARR cot 60°	DN	Cod	Preț [EUR / buc]	Notă
	60	PBSB65	9,70	alb
	80	PBSB68	10,00	
	80	PWSB68	10,00	
	110	PBSB61	14,00	
	125	PBSB62	29,90	
	160	PBSB66	41,00	
	200	PBSB60	65,70	
	250	PBSB6V	119,70	
	315	PBSB63	226,30	

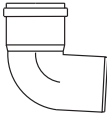
STARR cot 87°	DN	Cod	Preț [EUR / buc]	Notă
	60	PBSB95	6,10	alb
	80	PBSB98	6,30	
	80	PWSB98	6,30	
	110	PBSB91	9,10	
	125	PBSB92	20,40	
	160	PBSB96	27,70	
	200	PBSB90	73,40	
	250	PBSB9V	130,60	
	315	PBSB93	221,60	

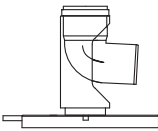
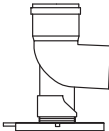
STARR baza cu cot 87° si consola	DN	Cod	Preț [EUR / buc]	Notă
	60	PBTU05	31,00	alb
	80	PBTU08	32,20	
	80	PWTU08	32,20	
	110	PBTU01	43,80	
	125	PBTU02	66,50	
	160	PBTU06	80,20	
	200	PBTU00	114,20	
	250	PBTU0V	188,10	
	315	PBTU03	277,10	
	-	-	-	

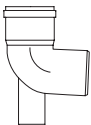
STARR cot 87° cu suport	DN	Cod	Preț [EUR / buc]	Notă
	60 (60)	PBTUS5	25,90	alb
	80 (60)	PBTUS8	28,10	
	80 (60)	PWTUS8	28,10	
	110 (80)	PBTUS1	35,50	
	125 (110)	PBTUS2	56,10	

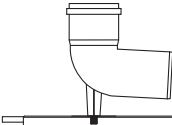
STARR cot 87° cu ancorare	DN	Cod	Preț [EUR / buc]	Notă
	60	PBTUB5	27,30	
	80	PBTUB8	27,50	
	-	-	-	
	-	-	-	
	-	-	-	
	-	-	-	

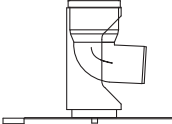
STARR baza cu cot 87° redus si consola	DN	Cod	Preț [EUR / buc]	Notă
	60 / 80	PBTU58	41,40	alb
	60 / 80	PWTU58	41,40	
	80 / 110	PBTU81	55,70	
	110 / 125	PBTU12	90,60	
	125 / 160	PBTU26	110,00	
-	-	-	-	

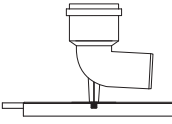
STARR cot 87° redus cu ancorare	DN	Cod	Preț [EUR / buc]	Notă
	60 / 80	PBTUB58	35,30	
	-	-	-	
	-	-	-	
	-	-	-	
	-	-	-	
	-	-	-	

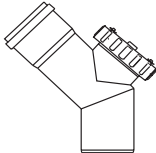
STARR cot 45° cu revizie	DN	Cod	Preț [EUR / buc]	Notă
	60	PBRB45	29,90	alb
	80	PBRB48	29,90	
	80	PWRB48	29,90	
	110	PBRB41	41,80	
	125	PBRB42	66,70	
	160	PBRB46	90,20	
	200	PBRB40	130,60	
	250	PBRB4V	210,20	
	315	PBRB43	286,70	

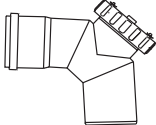
STARR cot 87° cu revizie	DN	Cod	Preț [EUR / buc]	Notă
	60	PBRB95	23,60	alb
	80	PBRB98	23,60	
	80	PWRB98	23,60	
	110	PBRB91	41,60	
	125	PBRB92	65,90	
	160	PBRB96	90,00	
	200	PBRB90	138,70	
	250	PBRB9V	192,80	
	315	PBRB93	309,30	

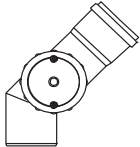
STARR cot 45° cu revizie (dreapta)	DN	Cod	Preț [EUR / buc]	Notă
	60	PBRR45	23,60	alb
	80	PBRR48	29,90	
	80	PWRR48	29,90	
	110	PBRR41	43,80	
	125	PBRR42	65,50	
	160	PBRR46	90,20	
	200	PBRR40	119,70	
	250	PBRR4V	191,80	
	315	PBRR43	286,70	

SISTEM FIX EVACUARE FUM DN 60 – 315 mm

STARR

PPH

STARR cot 45° cu revizie (stânga)	DN	Cod	Preț [EUR / buc]	Notă
	60	PBRL45	23,60	
	80	PBRL48	29,90	
	80	PWRL48	29,90	alb
	110	PBRL41	43,80	
	125	PBRL42	65,50	
	160	PBRL46	90,20	
	200	PBRL40	119,70	
	250	PBRL4V	191,80	
	315	PBRL43	286,70	

STARR cot 87° cu revizie (dreapta)	DN	Cod	Preț [EUR / buc]	Notă
	60	PBRR95	28,10	
	80	PBRR98	29,90	
	80	PWRR98	29,90	alb
	110	PBRR91	43,80	
	125	PBRR92	65,50	
	160	PBRR96	90,20	
	200	PBRR90	137,90	
	250	PBRR9V	199,70	
	315	PBRR93	309,30	

STARR cot 87° cu revizie (stânga)	DN	Cod	Preț [EUR / buc]	Notă
	60	PBRL95	28,10	
	80	PBRL98	29,90	
	80	PWRL98	29,90	alb
	110	PBRL91	43,80	
	125	PBRL92	65,50	
	160	PBRL96	90,20	
	200	PBRL90	137,90	
	250	PBRL9V	199,70	
	315	PBRL93	309,30	

STARR cot de 87° cu vizor service	DN	Cod	Preț [EUR / buc]	Notă
	60	PBSBM5	16,30	
	80	PBSBM8	16,70	
	80	PWSBM8	16,70	alb
	110	PBSBM1	20,40	
	125	PBSBM2	38,10	
	160	PBSBM6	55,50	
	200	PBSBM0	61,40	

STARR tub cu vizor service	DN	Cod	Preț [EUR / buc]	Notă
	60	PBMS05	17,10	
	80	PBMS08	17,70	
	80	PWMS08	17,70	alb
	110	PBMS01	22,20	
	125	PBMS02	29,50	
	160	PBMS06	38,70	
	200	PBMS00	63,00	
	250	PBMS0V	101,20	
	315	PBMS03	187,10	

STARR tub cu scurgere condens	DN	Cod	Preț [EUR / buc]	Notă
	60	PBKFO5	24,40	
	80	PBKFO8	27,90	
	80	PWKFO8	27,90	alb
	110	PBKFO1	36,10	
	125	PBKFO2	43,60	
	160	PBKFO6	54,60	
	200	PBKFO0	100,80	
	250	PBKFOV	149,50	
	315	PBKFO3	199,50	

STARR tub cu scurgere condens și vizor service	DN	Cod	Preț [EUR / buc]	Notă
	60	PBKFM5	29,50	
	80	PBKFM8	35,70	
	80	PWKFM8	35,70	alb
	110	PBKFM1	49,30	
	125	PBKFM2	59,70	
	160	PBKFM6	74,60	
	200	PBKFM0	113,60	
	250	PBKFMV	162,60	
	315	PBKFM3	191,80	

STARR colector condens cu priză	DN	Cod	Preț [EUR / buc]	Notă
	60	PBMA05	16,10	
	80	PBMA08	17,70	
	80	PWMA08	17,70	alb
	110	PBMA01	21,00	
	125	PBMA02	31,40	
	160	PBMA06	39,30	
	200	PBMA00	71,20	
	250	PBMA0V	106,30	
	315	PBMA03	107,90	

STARR conector filetat	DN	Cod	Preț [EUR / buc]	Notă
	60	PBSV05	22,80	
	80	PBSV08	23,00	
	80	PWSV08	23,00	alb
	110	PBSV01	34,20	
	125	PBSV02	48,10	
	160	PBSV06	60,40	
	200	PBSV00	187,10	

Amortizorul de zgomot gazelor arse	DN	Cod	Preț [EUR / buc]	Notă
	0,50 m	60	PBSD55	100,60
		60	PBSD15	111,80
	1,00 m	80	PBSD58	112,80
		80	PBSD18	127,30
	0,50 m	110	PBSD51	152,00
		110	PBSD11	202,40
	1,00 m	125	PBSD52	301,60
		125	PBSD12	390,40

ZUB colier distanțier (universal)	Număr piese	Cod	Preț [EUR / buc]	Notă
	1 pachet	PPFR60	8,50	1 pachet conține 6 segmenti/buc Ø 60 – 3 buc Ø 80 – 4 buc Ø 110 – 5 buc Ø 125 – 6 buc Ø 160 – 7 buc Ø 200 – 9 buc
	15 pachet	PPFR15	116,30	
	-	-	-	
	-	-	-	
	-	-	-	
	DN 80	PPFRN8	4,40	

STARR dop	DN	Cod	Preț [EUR / buc]	Notă
	60	PBEN05	16,10	
	80	PBEN08	17,90	
	80	PWEN08	17,90	alb
	110	PBEN01	21,20	
	125	PBEN02	29,10	
	160	PBEN06	41,40	
	200	PBEN00	74,00	
	315	PBEN03	128,10	

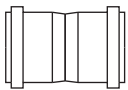
STARR mufa-Mufă (pentru aer)	DN	Cod	Preț [EUR / buc]	Notă
	60	PBDM05	14,00	
	80	PBDM08	16,70	
	80	PWDM08	16,70	alb
	110	PBDM01	18,10	
	125	PBDM02	30,00	
	160	PBDM06	42,80	
200	PBDM00	109,90		

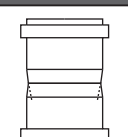
STARR mufa-Mufă (pentru fum)	DN	Cod	Preț [EUR / buc]	Notă
	60	PBDMK5	15,00	
	80	PBDMK8	18,70	
	80	PWDMK8	18,70	alb
	110	PBDMK1	23,00	
	125	PBDMK2	40,20	
	160	PBDMK6	54,00	
200	PBDMK0	106,30		

Șantul interior trebuie. Instalat întotdeauna în aval condensului.

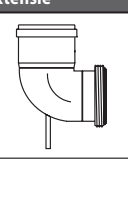
STARR cot 87° cu extensie	DN	Cod	Preț [EUR / buc]	Notă
	60	PBEB05	47,50	
	80	PBEB08	49,50	
	80	PWEB08	49,50	alb
	-	-	-	
	-	-	-	
	-	-	-	
	-	-	-	

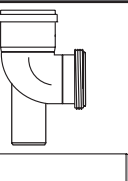
STARR cot 87° cu suport și extensie	DN	Cod	Preț [EUR / buc]	Notă
	60 (60)	PBES05	57,50	
	80 (80)	PBES08	66,70	
	80 (80)	PWES08	66,70	alb
	110 (80)	PBES01	86,10	
	125 (110)	PBES02	105,30	
	160 (110)	PBES06	138,10	
	-	-	-	

(DN support)

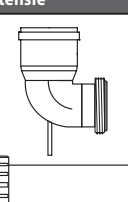
STARR cot 87° redus și extensie	DN	Cod	Preț [EUR / buc]	Notă
	60 / 80	PBEB58	56,90	
	-	-	-	
	-	-	-	
	-	-	-	
	-	-	-	
	-	-	-	
	-	-	-	

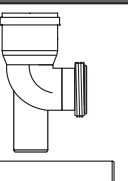
STARR cot 87° redus cu suport și extensie	DN	Cod	Preț [EUR / buc]	Notă
	60 / 80 (60)	PBES58	74,20	
	-	-	-	
	-	-	-	
	-	-	-	
	-	-	-	
	-	-	-	
	-	-	-	

(DN support)

STARR placa universală pentru coș/plastic negru	DN	Cod	Preț [EUR / buc]	Notă
	60-160	PPKPU0	47,50	400x400 mm
	-	-	-	
	-	-	-	
	-	-	-	

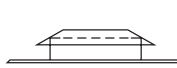
STARR placa de coș din inox cu guler	DN	Cod	Preț [EUR / buc]	Notă
	200	IVEKPA20	92,20	400x400 mm
	250	IVEKPA25	96,90	450x450 mm
	315	IVEKPA31	104,80	515x515 mm

STARR guler antipluvial	DN	Cod	Preț [EUR / buc]	Notă
	60	PPWS05	17,70	
	80	PPWS08	18,50	
	110	PPWS01	20,20	
	125	PPWS02	24,20	
	160	PPWS06	27,90	

STARR guler antipluvial conic	DN	Cod	Preț [EUR / buc]	Notă
	60	PPWS52	17,70	
	80	PPWS82	18,50	
	110	PPWS12	34,00	
	-	-	-	

STARR guler de ploaie p/tub de capăt	DN	Cod	Preț [EUR / buc]	Notă
	60 / 250	PPWS5V	76,70	
	80 / 250	PPWS8V	78,10	
	110 / 250	PPWS1V	78,90	
	125 / 250	PPWS2V	80,80	
	160 / 250	PPWS6V	65,70	
	200 / 250	PPWS0V	72,40	
	200 / 315	PPWS03	83,00	
	250 / 315	PPWSV3	85,00	

STARR tub de capăt fără mufa	DN	Cod	Preț [EUR / buc]	Notă
	60	PPRS55	6,50	
	80	PPRS58	8,70	
	110	PPRS51	10,60	
	125	PPRS52	16,70	
	160	PPRS56	23,60	
	200	PPRS50	58,30	
	250	PPRS5V	108,70	
	315	PPRS53	157,50	

0,50 m

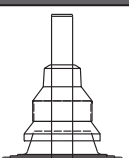
STARR terminație coș din plastic (set)	DN	Cod	Preț [EUR / buc]	Notă
	60	PPSAS5	52,80	
	80	PPSAS8	57,30	
	110	PPSAS1	78,10	
	125	PPSAS2	94,00	
	160	PPSAS6	109,90	
	-	-	-	

Set conține:
Placă de coș de fum 400 x 400 mm.
Guler de ploaie.
Tub de capăt fără mufa 50 cm.

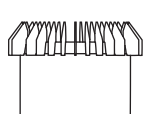
STARR extensie terminație de coș din plastic (set)	DN	Cod	Preț [EUR / buc]	Notă
	60-160	PPKMS0	18,50	
	-	-	-	
	-	-	-	
	-	-	-	
	-	-	-	

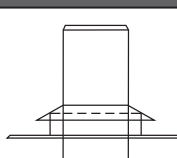
STARR terminație coș (set) din inox	DN	Cod	Preț [EUR / buc]	Notă
	200	ESTAV0	143,60	400x400 mm
	250	ESTAVV	178,10	450x450 mm
	315	ESTAV3	233,80	515x515 mm
	-	-	-	
	-	-	-	
	-	-	-	

Tub de capăt fără mufa 50 cm.
Placă de coș.

SISTEM FIX EVACUARE FUM
DN 60 – 315 mm

STARR reductie centrala - centrică	DN	Cod	Preț [EUR / buc]	Notă
Tub DN 60	50	PBKA51	27,30	
	63	PBKA52	27,70	
	70	PBKA53	30,20	
	75	PBKA54	27,70	
	80	PBKA55	21,60	
Tub DN 80	60	PBKA01	16,30	
	60	PWKA01	16,30	alb
	63	PBKA02	23,60	
	70	PBKA03	29,10	
	75	PBKA04	29,90	
	100	PBKA23	31,40	
	110	PBKA24	32,20	
125	PBKA81	34,40		
Tub DN 110	60	PBKA41	25,90	
	63	PBKA42	26,30	
	70	PBKA43	27,50	
	75	PBKA07	27,70	
	80	PBKA08	29,90	
	100	PBKA09	32,20	
	125	PBKA26	40,40	
	130	PBKA10	40,80	
	150	PBKA11	41,80	
153	PBKA25	42,40		
Tub DN 125	80	PBKA06	39,30	
	100	PBKA12	39,70	
	110	PBKA13	40,40	
	130	PBKA14	43,80	
	150	PBKA15	45,90	
	153	PBKA16	49,50	
	160	PBKA38	51,00	
	200	PBKA39	57,70	
Tub DN 160	80	PBKA61	46,30	
	100	PBKA17	46,50	
	110	PBKA18	47,90	
	125	PBKA19	50,40	
	130	PBKA20	62,40	
	150	PBKA21	63,60	
	153	PBKA22	64,20	
	180	PBKA62	66,10	
200	PBKA63	68,70		
Tub DN 200	100	PBKA32	83,00	
	110	PBKA30	85,00	
	125	PBKA35	89,50	
	130	PBKA31	92,60	
	150	PBKA33	93,20	
	153	PBKA34	93,60	
	160	PBKA27	94,00	
	180	PBKA28	96,30	
	225	PBKA36	98,50	
250	PBKA37	100,80		
Tub DN 250	150	PBKAV1	120,80	
	160	PBKAV2	121,40	
	180	PBKAV3	141,40	
	200	PBKAV4	123,80	
	225	PBKAV5	144,20	
Tub DN 315	200	PBKA64	146,50	
	225	PBKA65	147,90	
	250	PBKA66	148,30	
	300	PBKA67	173,20	



Alte dimensiuni la cerere

STARR reductie centrala - excentrică	DN	Cod	Preț [EUR / buc]	Notă
Tub DN 60	50	PBKX51	21,60	
	63	PBKX52	22,60	
	70	PBKX53	23,00	
	75	PBKX54	23,40	
	80	PBKX55	24,20	
Tub DN 80	60	PBKX01	29,90	
	60	PWKX01	29,90	alb
	63	PBKX02	30,20	
	70	PBKX03	38,90	
	75	PBKX04	42,00	
	100	PBKX23	43,20	
	110	PBKX24	43,80	
	125	PBKX81	45,90	
	125	PBKX05	45,90	
Tub DN 110	60	PBKX41	34,60	
	63	PBKX42	37,30	
	70	PBKX43	41,60	
	75	PBKX07	42,00	
	80	PBKX08	42,40	
	100	PBKX09	43,20	
	125	PBKX26	52,60	
	130	PBKX10	58,30	
	150	PBKX11	60,40	
	153	PBKX25	68,10	
	153	PBKX06	68,10	
	153	PBKX27	68,10	
	153	PBKX28	68,10	
Tub DN 125	80	PBKX06	46,70	
	100	PBKX12	51,80	
	110	PBKX13	55,10	
	130	PBKX14	62,60	
	150	PBKX15	69,10	
	153	PBKX16	70,40	
	160	PBKX38	71,60	
	200	PBKX39	73,40	
	200	PBKX17	73,40	
	200	PBKX18	73,40	
Tub DN 160	80	PBKX61	66,90	
	100	PBKX17	71,20	
	110	PBKX18	75,90	
	125	PBKX19	75,50	
	130	PBKX20	91,60	
	150	PBKX21	94,00	
	153	PBKX22	95,00	
	180	PBKX62	96,70	
	200	PBKX63	99,30	
	200	PBKX19	99,30	
Tub DN 200	100	PBKX32	98,10	
	110	PBKX30	98,50	
	125	PBKX35	99,90	
	130	PBKX31	111,40	
	150	PBKX33	111,80	
	153	PBKX34	111,80	
	160	PBKX27	107,90	
	180	PBKX28	123,00	
	225	PBKX36	124,60	
	250	PBKX37	127,30	
Tub DN 250	150	PBKXV1	152,00	
	160	PBKXV2	153,20	
	180	PBKXV3	162,60	
	200	PBKXV4	156,70	
	225	PBKXV5	169,50	
Tub DN 315	200	PBKX64	172,20	
	225	PBKX65	193,40	
	250	PBKX66	200,60	
	300	PBKX67	203,80	

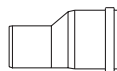

Alte dimensiuni la cerere

STARR reductie centrala cu vizor service	DN	Cod	Preț [EUR / buc]	Notă
Tub DN 60	50	PBKM51	45,10	
	63	PBKM52	48,30	
	70	PBKM53	48,30	
	75	PBKM54	45,70	
	80	PBKM55	24,40	
Tub DN 80	60	PBKM01	25,90	
	60	PWKM01	25,90	alb
	63	PBKM02	26,70	
	70	PBKM03	29,70	
	75	PBKM04	27,10	
	100	PBKM23	33,00	
	110	PBKM24	33,60	
Tub DN 110	125	PBKM028	35,50	
	60	PBKM051	40,20	
	63	PBKM631	40,40	
	70	PBKM43	44,00	
	75	PBKM07	40,40	
	80	PBKM08	40,20	
	100	PBKM09	35,10	
	125	PBKM26	42,80	
Tub DN 125	130	PBKM10	48,70	
	150	PBKM11	48,70	
	153	PBKM25	48,70	
	80	PBKM06	49,50	
	100	PBKM12	49,30	
	110	PBKM13	50,20	
	130	PBKM14	58,90	
	150	PBKM15	58,90	
Tub DN 160	153	PBKM16	58,90	
	160	PBKM062	54,60	
	200	PBKM002	71,80	
	80	PBKM61	62,00	
	100	PBKM17	61,80	
	110	PBKM18	62,40	
	125	PBKM19	64,20	
	130	PBKM20	73,00	
Tub DN 200	150	PBKM21	73,00	
	153	PBKM22	73,00	
	180	PBKM186	82,40	
	200	PBKM006	76,10	
	100	PBKM100	125,70	
	110	PBKM30	126,50	
	125	PBKM35	128,30	
	130	PBKM130	138,90	
Tub DN 250	150	PBKM150	138,90	
	153	PBKM530	138,90	
	160	PBKM27	130,60	
	180	PBKM28	142,40	
	225	PBKM220	133,20	
	250	PBKM250	139,50	
	150	PBKMV1	155,10	
	160	PBKMV2	140,00	
Tub DN 315	180	PBKMV3	151,80	
	200	PBKMV4	142,80	
	225	PBKMV5	142,80	
	200	PBKM64	252,20	
225	PBKM65	274,60		
250	PBKM66	264,40		
300	PBKM67	292,60		



Alte dimensiuni la cerere

STARR tub inspecție redus cu schimbarea direcției si vizor service	DN	Cod	Preț [EUR / buc]	Notă
Tub DN 60	50	PBKT51	58,30	
	63	PBKT52	37,30	
	70	PBKT53	51,00	
	75	PBKT54	37,50	
	80	PBKT55	37,30	
Tub DN 80	60	PBKT01	39,30	
	60	PWKT01	39,30	alb
	63	PBKT02	39,50	
	70	PBKT03	53,20	
	75	PBKT04	39,70	
	100	PBKT23	45,10	
	110	PBKT24	46,30	
	125	PBKT028	48,10	
Tub DN 110	60	PBKT051	73,00	
	63	PBKT631	73,20	
	70	PBKT43	77,30	
	75	PBKT07	73,40	
	80	PBKT08	71,00	
	100	PBKT09	65,90	
	125	PBKT26	71,60	
	130	PBKT10	80,20	
	150	PBKT11	80,20	
	153	PBKT25	80,20	
Tub DN 125	60	PBKTR52	109,90	
	80	PBKT06	113,20	
	100	PBKT12	113,00	
	110	PBKT13	113,80	
	130	PBKT14	123,60	
	150	PBKT15	123,60	
	153	PBKT16	123,60	
	160	PBKT062	117,90	
Tub DN 160	200	PBKT002	139,10	
	80	PBKT61	155,10	
	100	PBKT17	155,10	
	110	PBKT18	155,90	
	125	PBKT19	157,90	
	130	PBKT20	167,30	
	150	PBKT21	167,30	
	153	PBKT22	167,30	
Tub DN 200	180	PBKT186	176,70	
	200	PBKT006	169,70	
	80	PBKTR80	239,90	
	100	PBKT100	239,90	
	110	PBKT30	240,60	
	125	PBKT35	242,40	
	130	PBKT130	254,20	
	150	PBKT150	254,20	
	153	PBKT530	254,20	
	160	PBKT27	230,00	
Tub DN 250	180	PBKT28	249,70	
	225	PBKT220	249,70	
	250	PBKT250	246,90	
	110	PBKTR1V	274,60	
	125	PBKTR2V	275,90	
	150	PBKTV1	294,80	
	160	PBKTV2	272,20	
	180	PBKTV3	291,20	
	200	PBKTV4	275,00	
	225	PBKTV5	291,20	
Tub DN 315	110	PBKTR13	420,40	
	125	PBKTR23	423,20	
	160	PBKTR63	429,10	
	200	PBKT64	420,60	
	225	PBKT65	456,70	
	250	PBKT66	432,80	
	300	PBKT67	467,90	

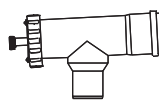

Alte dimensiuni la cerere

SISTEM FIX EVACUARE FUM
DN 60 – 315 mm

STARR Y tub	DN	Cod	Preț [EUR / buc]	Notă
	80 / 2x60	PBHR58	68,70	
	110 / 2x60	PBHR51	71,00	
	110 / 2x80	PBHR81	70,20	
	125 / 2x60	PBHR52	79,50	
	125 / 2x80	PBHR82	76,90	
	125 / 2x110	PBHR12	83,20	
	160 / 2x60	PBHR56	92,40	
	160 / 2x80	PBHR86	92,60	
	160 / 2x110	PBHR16	95,90	
	160 / 2x125	PBHR26	115,00	
	200 / 2x60	PBHR50	116,90	
	200 / 2x80	PBHR80	117,10	
	200 / 2x110	PBHR10	120,40	
	200 / 2x125	PBHR20	139,50	
	200 / 2x160	PBHR60	151,40	
	250 / 2x60	PBHR5V	137,30	
	250 / 2x80	PBHR8V	137,50	
	250 / 2x110	PBHR1V	141,00	
	250 / 2x125	PBHR2V	161,20	
	250 / 2x160	PBHR6V	181,20	
	250 / 2x200	PBHR0V	214,60	
	315 / 2x60	PBHR53	la cerere	
	315 / 2x80	PBHR83	la cerere	
	315 / 2x110	PBHR13	la cerere	
	315 / 2x125	PBHR23	la cerere	
	315 / 2x160	PBHR63	la cerere	
	315 / 2x200	PBHR03	la cerere	
	315 / 2x250	PBHRV3	la cerere	

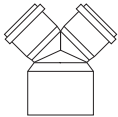

Set pentru coș de fum Starr	DN	Cod	Cod set	Preț [EUR / buc]	Notă
<p>4x (SETS05B) 3x (SETS07B) 3x (SETS08B)</p> <p>(SETS07B) (SETS05B) (SETS08B)</p>	60	-	SETS05B	110,00	
	Conține:				
	60	PBTU05	STARR baza cu cot 87° si consola		1x
	-	PPFR60	ZUB colier distanțier (universal)		2x (adică 4 coliere)
	60	PPKPU0	STARR placă universală pentru coș (plastic)		1x
	60	PPWS52	STARR guler antipluvial conic		1x
	-	ZUSF05	ZUB lubrifiant siliconic 50 g		1x
	60 / 80	-	SETS07B	116,90	reduc
	Conține:				
	60 / 80	PBTU58	STARR baza cu cot 87° redus si consola		1x
	-	PPFRN8	ZUB colier distanțier (universal)		3x
	80	PPKPU0	STARR placă universală pentru coș (plastic)		1x
	80	PPWS82	STARR guler antipluvial conic		1x
	-	ZUSF05	ZUB lubrifiant siliconic 50 g		1x
	80	-	SETS08B	108,10	
	Conține:				
	80	PBTU08	STARR baza cu cot 87° si consola		1x
	-	PPFRN8	ZUB colier distanțier (universal)		3x
	80	PPKPU0	STARR placă universală pentru coș (plastic)		1x
	80	PPWS82	STARR guler antipluvial conic		1x
-	ZUSF05	ZUB lubrifiant siliconic 50 g		1x	

STARR terminație coș din plastic (set)
pentru DN 60-125 mm

FLEX terminație coș (set) din plastic
pentru DN 160 mm

FLEX terminație coș (set) din inox
pentru DN 200 mm

ZUB colier distanțier (universal)

FLEX tubulatura

FLEX teu revizie flex

ZUB usita revizie

FLEX tubulatura

ZUB colier distanțier (universal)

FLEX colier de blocare

FLEX cot 87° cu suport și ancorare

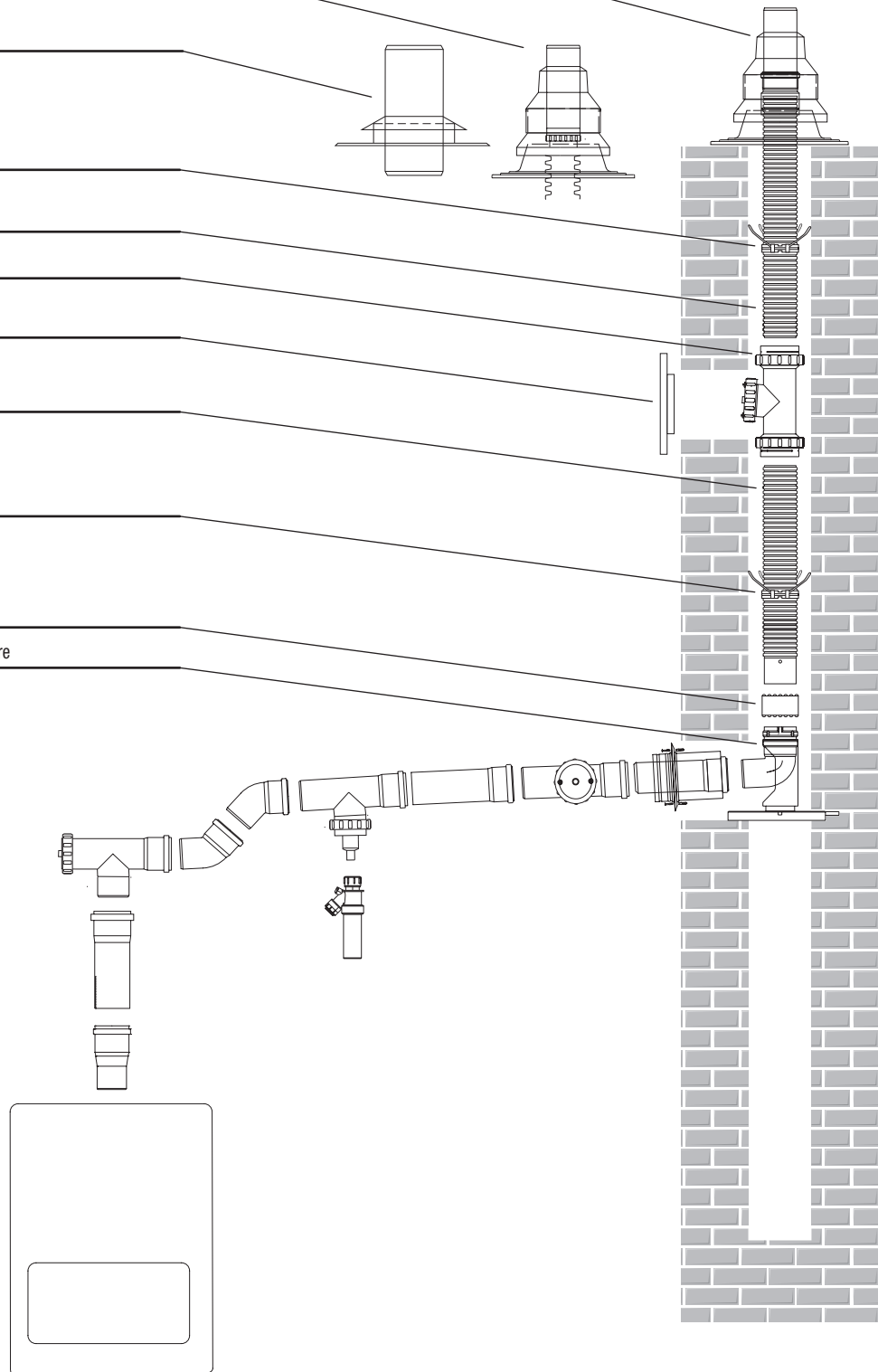



SISTEM FLEXIBIL EVACUARE FUM

DN 60 – 125 mm



FLEX



PPH

FLEX tubulatura	Pachet [m]	DN	Cod	Preț [EUR / buc]	Notă	
	15	60	PPRF15	195,10	Pret pachet	
	30	60	PPRF35	354,40		
	50	60	PPRF55	530,60		
	15	80	PPRF18	205,30		
	30	80	PPRF38	372,80		
	50	80	PPRF58	558,70		
	15	110	PPRF1X	269,30		
	30	110	PPRF3X	489,30		
	50	110	PPRF5X	734,00		
	15	125	PPRF12	352,60		
	30	125	PPRF32	640,60		
	50	125	PPRF52	961,00		
	-	-	-	-		-
	-	-	-	-		-

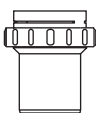
FLEX tubulatura 1,0 m	DN	Cod	Preț [RON / m]	Notă
	60	PPRF05	14,60	Livrare în multipli 1m.
	80	PPRF08	15,10	
	110	PPRF0X	20,00	
	125	PPRF02	25,90	
	-	-	-	
-	-	-	-	-

FLEX tubulatura în boxa (50 m)	DN	Cod	Preț [EUR / buc]	Notă
	80	PPRFB8	582,20	Ambalare: 50m dimensiuni cutie: 1020 x 1034 x 820 mm (l x h x p)
	-	-	-	
	-	-	-	
	-	-	-	
	-	-	-	

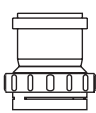
Adaptor starr / flex	DN	Cod	Preț [EUR / buc]	Notă
	60	PPAES5	14,60	Trebuie folosit clemă de blocare flex
	80	PPAES8	17,30	
	-	-	-	
	-	-	-	
	110	PPAES1	31,80	
	125	PPAES2	33,60	
	-	-	-	
	-	-	-	

FLEX adaptor flex / starr	DN	Cod	Preț [EUR / buc]	Notă
	60	PPAMS5	21,60	Trebuie folosit clemă de blocare flex
	80	PPAMS8	24,40	
	-	-	-	
	-	-	-	
	110	PPAMS1	40,00	
	125	PPAMS2	55,00	
	-	-	-	
	-	-	-	

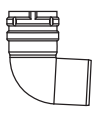
FLEX adaptor starr / flex 87°	DN	Cod	Preț [EUR / buc]	Notă
	60	PPAFS5	18,30	Trebuie folosit colier de blocare flex
	80	PPAFS8	19,90	
	110	PPAF1X	30,20	
	125	PPAFS2	42,80	
	-	-	-	

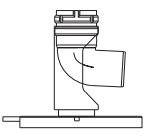
FLEX cot 87° cu suport și ancorare	DN	Cod	Preț [EUR / buc]	Notă
	60	PPSTF5	36,70	Trebuie folosit colier de blocare flex
	80	PPSTF8	37,70	
	110	PPSTF1	47,10	
	125	PPSTF2	80,60	
	-	-	-	

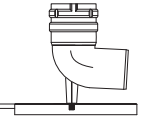
FLEX cot 87° cu consola	DN	Cod	Preț [EUR / buc]	Notă
	60	PBUTF5	33,40	
	80	PBUTF8	33,80	
	-	-	-	
	-	-	-	
	-	-	-	

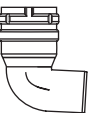
FLEX adaptor 87° redus	DN	Cod	Preț [EUR / buc]	Notă
	60 / 80	PPAF58	20,60	Trebuie folosit colier de blocare flex
	80 / 110	PPAF8X	33,00	
	110 / 125	PPAF12	47,50	
	-	-	-	
	-	-	-	

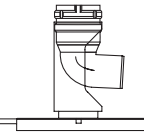
FLEX cot 87° redus cu suport și ancorare	DN	Cod	Preț [EUR / buc]	Notă
	60 / 80	PPSTF58	41,00	Trebuie folosit colier de blocare flex
	80 / 110	PPSTF8X	57,30	
	110 / 125	PPSTF12	89,70	
	-	-	-	
	-	-	-	

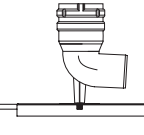
FLEX cot 87° redus cu consola	DN	Cod	Preț [EUR / buc]	Notă
	60 / 80	PBUTF58	35,70	
	-	-	-	
	-	-	-	
	-	-	-	
	-	-	-	

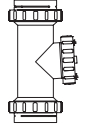
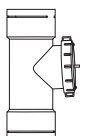
FLEX teu revizie flex	DN	Cod	Preț [EUR / buc]	Notă
	60	PPTXF5	54,00	Trebuie folosit 2x clemă de blocare flex
	80	PPTXF8	60,20	
	-	-	-	
	-	-	-	
	-	-	-	
	-	-	-	
	110	PPTXFX	85,50	
	125	PPTXF2	126,30	
	-	-	-	
	-	-	-	
	-	-	-	
	-	-	-	

FLEX garnitura etansare	DN	Cod	Preț [EUR / buc]	Notă
	60	ZUMDF5	2,00	Trebuie folosit pentru conexiune tuburilor flexibile
	80	ZUMDF8	2,20	
	110	ZUMDFX	3,00	
	125	ZUMDF2	3,80	
	-	-	-	

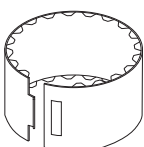
FLEX colier de blocare	DN	Cod	Preț [EUR / buc]	Notă	
	60	ZUBF05	15,30		
	80	ZUBF08	15,70		
	110	ZUBFOX	16,30		
	125	ZUBF02	16,90		
	-	-	-	-	
	-	-	-	-	

FLEX clemă de blocare	DN	Cod	Preț [EUR / buc]	Notă
	60	ZUHF05	8,90	
	80	ZUHF08	9,10	
	110	ZUHFOX	11,00	
	125	ZUHFO2	11,40	
	-	-	-	-

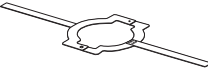
FLEX clemă de ancorare	DN	Cod	Preț [EUR / buc]	Notă
	60	ZUHFA5	12,20	
	80	ZUHFA8	12,40	
	110	ZUHFA8	13,60	
	125	ZUHFA2	15,00	
	-	-	-	-

STARR tub de capăt fără mufa	DN	Cod	Preț [EUR / buc]	Notă
	60	PPRS55	6,50	
	80	PPRS58	8,70	
	110	PPRS51	10,60	
	125	PPRS52	16,70	
	-	-	-	-

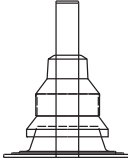
STARR terminație coș din plastic (set)	DN	Cod	Preț [EUR / buc]	Notă	
	60	PPSAS5	52,80	Set conține: Placă coș de fum 400 x 400 mm. Guler de ploaie. Tub terminal fără mufa 50 cm.	
	80	PPSAS8	57,30		
	110	PPSAS1	78,10		
	125	PPSAS2	94,00		
	-	-	-		
	-	-	-		

STARR extensie terminație coș din plastic (set)	DN	Cod	Preț [EUR / buc]	Notă
	60-160	PPKMS0	18,50	
	-	-	-	
	-	-	-	
	-	-	-	
	-	-	-	

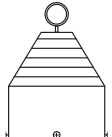
FLEX con evacuare flexibil	DN	Cod	Preț [EUR / buc]	Notă	
	60	ZUEZH5	40,40	Frângia nu este furnizată	
	80	ZUEZH8	40,60		
	110	ZUEZH1	41,80		
	125	ZUEZH2	43,00		
	-	-	-		
	-	-	-		

STARR guler antipluvial	DN	Cod	Preț [EUR / buc]	Notă
	60	PPWS05	17,70	
	80	PPWS08	18,50	
	110	PPWS01	20,20	
	125	PPWS02	24,20	
	-	-	-	-

STARR guler antipluvial conic	DN	Cod	Preț [EUR / buc]	Notă
	60	PPWS52	17,70	
	80	PPWS82	18,50	
	110	PPWS12	34,00	
	-	-	-	
	-	-	-	

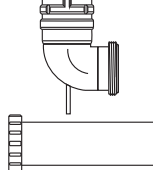
FLEX cot 87° cu extensie	DN	Cod	Preț [EUR / buc]	Notă
	60	PBEBF5	56,70	
	80	PBEBF8	59,30	
	80	PWEBF8	59,30	alb
	-	-	-	
	-	-	-	
	-	-	-	

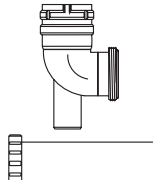
FLEX cot 87° cu suport și extensie	DN	Cod	Preț [EUR / buc]	Notă
	60	PBESF5	61,80	Trebuie folosit colier de blocare flex
	80	PBESF8	72,20	
	-	-	-	
	-	-	-	
	-	-	-	
	-	-	-	

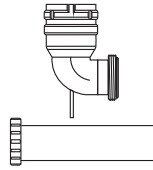
FLEX cot 87° redus cu extensie	DN	Cod	Preț [EUR / buc]	Notă
	60 / 80	PBEBF58	62,60	Trebuie folosit colier de blocare flex
	-	-	-	
	-	-	-	
	-	-	-	
	-	-	-	
	-	-	-	

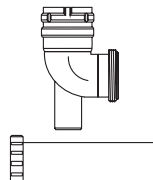
FLEX cot 87° redus cu suport și extensie	DN	Cod	Preț [EUR / buc]	Notă
	60 / 80	PBESF58	75,50	Trebuie folosit colier de blocare flex
	-	-	-	
	-	-	-	
	-	-	-	
	-	-	-	
	-	-	-	

SISTEM FLEXIBIL EVACUARE FUM
DN 160 – 200 mm

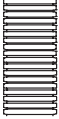
FLEX tubulatura	DN	Cod	Cena [Kč / bm]	Notă
	160	PURF75	39,50	rola 25 m
	200	PURF00	45,10	rola 30 m
	-	-	-	Livrare cu role întregi
	-	-	-	
	-	-	-	
	-	-	-	
	-	-	-	

FLEX conector flex / flex	DN	Cod	Preț [EUR / buc]	Notă
	160	PPKU06	85,30	Plastic, negru, UV stabil.
	200	PPKU00	246,30	
	-	-	-	
	-	-	-	
	-	-	-	
	-	-	-	

FLEX adaptor starr / flex	DN	Cod	Preț [EUR / buc]	Notă
	160	PBAE06	50,60	
	200	PBAE00	115,10	
	-	-	-	
	-	-	-	
	-	-	-	
	-	-	-	

FLEX adaptor flex / starr	DN	Cod	Preț [EUR / buc]	Notă
	160	PBAM06	74,80	
	200	PBAM00	169,50	
	-	-	-	
	-	-	-	
	-	-	-	
	-	-	-	

FLEX adaptor starr / flex 87°	DN	Cod	Preț [EUR / buc]	Notă
	160	PBAF96	80,20	
	200	PBAF90	180,40	
	-	-	-	
	-	-	-	
	-	-	-	
	-	-	-	

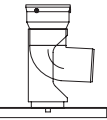
FLEX cot 87° cu suport și ancorare	DN	Cod	Preț [EUR / buc]	Notă
	160	PBTUF6	130,00	
	200	PBTUF0	241,40	
	-	-	-	
	-	-	-	
	-	-	-	
	-	-	-	
	-	-	-	

FLEX teu revizie flex	DN	Cod	Preț [EUR / buc]	Notă
	160	PBRTF6	177,30	
	200	PBRTF0	368,90	
	-	-	-	
	-	-	-	
	-	-	-	
	-	-	-	
	-	-	-	

FLEX tub de capăt	DN	Cod	Preț [EUR / buc]	Notă
	160	PPRSF6	64,00	Plastic, negru, UV stabil.
	200	PPRSF0	182,80	
	-	-	-	
	-	-	-	
	-	-	-	

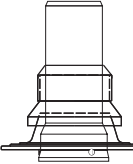
FLEX terminație coș (set) din plastic	DN	Cod	Preț [EUR / buc]	Notă
	160	PPSAF6	130,20	Set conține: Placa cos de fum 400 x 400 mm. Guler de ploaie. Tub terminal 30 cm UV stabil.
	-	-	-	
	-	-	-	
	-	-	-	
	-	-	-	
	-	-	-	
	-	-	-	

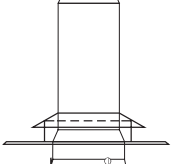
FLEX terminație coș (set) din inox	DN	Cod	Preț [EUR / buc]	Notă
	200	ESTAF0	240,40	Set conține: Placa cos de fum 400 x 400 mm. Guler de ploaie, inox. Tub terminal 30 cm UV stabil.
	-	-	-	
	-	-	-	
	-	-	-	
	-	-	-	
	-	-	-	
	-	-	-	

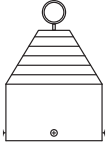
FLEX con evacuare flexibil	DN	Cod	Preț [EUR / buc]	Notă
	160	ZUEZH6	53,80	Frângia nu este furnizată
	200	ZUEZH0	61,60	
	-	-	-	
	-	-	-	
	-	-	-	
	-	-	-	

Set pentru coș de fum flex	DN	Cod	Cod set	Preț [EUR / buc]	Notă
	60 / 80	-	SETF07B	155,00	redus
	Conține:				
	60 / 80	PPSTF58	FLEX cot 87° redus cu suport si ancorare		1x
	80	ZUBF08	FLEX colier de blocare		1x
	80	PPFRN8	ZUB colier distanțier (universal)		3x
	80	ZUHF08	FLEX clemă de blocare		1x
	80	PPAMS8	FLEX adaptor flex / starr		1x
	80	PPSAS8	STARR terminație coș din plastic (set)		1x
	-	ZUSF05	ZUB lubrifianț siliconic 50 g		1x
	80	-	SETF08B	151,80	
	Conține:				
	80	PPSTF8	FLEX cot 87° cu suport si ancorare		1x
	80	ZUBF08	FLEX colier de blocare		1x
	80	PPFRN8	ZUB colier distanțier (universal)		3x
	80	ZUHF08	FLEX clemă de blocare		1x
	80	PPAMS8	FLEX adaptor flex / starr		1x
	80	PPSAS8	STARR terminație coș din plastic (set)		1x
	-	ZUSF05	ZUB lubrifianț siliconic 50 g		1x
	60 / 80	-	SETFE7B	175,30	redus
	Conține:				
60 / 80	PBEBF58	FLEX cot 87° redus cu extensie		1x	
80	ZUBF08	FLEX colier de blocare		1x	
80	PPFRN8	ZUB colier distanțier (universal)		3x	
80	ZUHF08	FLEX clemă de blocare		1x	
80	PPAMS8	FLEX adaptor flex / starr		1x	
80	PPSAS8	STARR terminație coș din plastic (set)		1x	
-	ZUSF05	ZUB lubrifianț siliconic 50 g		1x	
80	-	SETFE8B	172,20		
Conține:					
80	PBEBF8	FLEX cot 87° cu extensie		1x	
80	ZUBF08	FLEX colier de blocare		1x	
80	PPFRN8	ZUB colier distanțier (universal)		3x	
80	ZUHF08	FLEX clemă de blocare		1x	
80	PPAMS8	FLEX adaptor flex / starr		1x	
80	PPSAS8	STARR terminație coș din plastic (set)		1x	
-	ZUSF05	ZUB lubrifianț siliconic 50 g		1x	

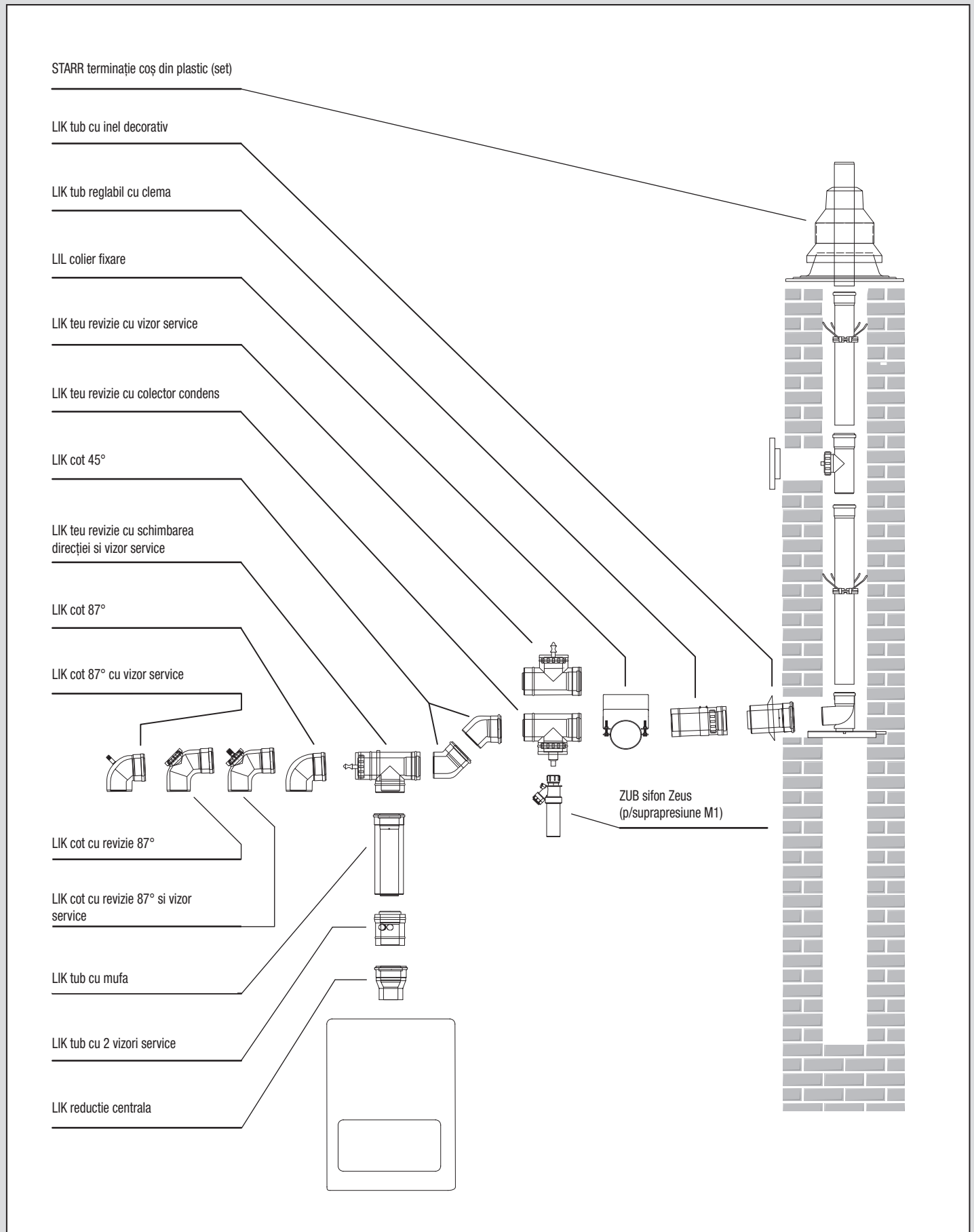

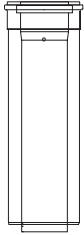
LIK tub cu mufa	DN	Cod	Preț [EUR / buc]	Notă	
	0,25 m	60 / 100	LPRK05	16,90	
		80 / 125	LPRK08	22,20	
		60 / 100	LPRK05-LET	21,20	Tub interior mai lung cu 30 mm
	0,50 m	-	-	-	
		60 / 100	LPRK55	20,00	
		80 / 125	LPRK58	26,50	
	1,00 m	-	-	-	
		60 / 100	LPRK15	25,90	
		80 / 125	LPRK18	39,90	
	2,00 m	-	-	-	
		60 / 100	LPRK25	50,60	
		80 / 125	LPRK28	66,50	

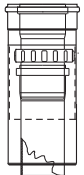
LIK tub reglabil cu clema	DN	Cod	Preț [EUR / buc]	Notă	
	0,20 - 0,32 m	60 / 100	LPSK25	67,90	
		80 / 125	LPSK28	73,40	
		-	-	-	
	0,29 - 0,50 m	60 / 100	LPSK55	75,10	
		80 / 125	LPSK58	84,00	
		-	-	-	
		-	-	-	

LIK cot 15°	DN	Cod	Preț [EUR / buc]	Notă
	60 / 100	LPBK15	35,50	
	80 / 125	LPBK18	44,20	
	-	-	-	
	-	-	-	
	-	-	-	
	-	-	-	

LIK cot 30°	DN	Cod	Preț [EUR / buc]	Notă
	60 / 100	LPBK35	35,50	
	80 / 125	LPBK38	43,00	
	-	-	-	
	-	-	-	
	-	-	-	
	-	-	-	

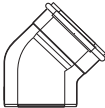
LIK cot 45°	DN	Cod	Preț [EUR / buc]	Notă
	60 / 100	LPBK45	22,20	
	80 / 125	LPBK48	30,00	
	-	-	-	
	-	-	-	
	-	-	-	
	-	-	-	

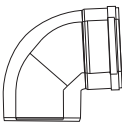
LIK cot 87°	DN	Cod	Preț [EUR / buc]	Notă
	60 / 100	LPBK95	22,40	
	80 / 125	LPBK98	32,80	
	60 / 100	LPBK95-LET	27,90	Tub interior mai lung cu 30 mm
	-	-	-	
	-	-	-	
	-	-	-	

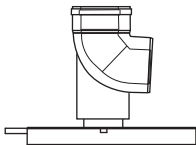
LIK baza cu cot 87° flex și consola	DN	Cod	Preț [EUR / buc]	Notă
	60 / 100	LPSKK5	70,60	
	80 / 125	LPSKK8	79,10	
	-	-	-	
	-	-	-	
	-	-	-	
	-	-	-	

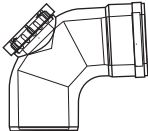
LIK cot 87° cu revizie	DN	Cod	Preț [EUR / buc]	Notă
	60 / 100	LPRBK5	78,70	
	80 / 125	LPRBK8	92,00	
	-	-	-	
	-	-	-	
	-	-	-	
	-	-	-	

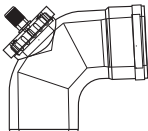
LIK cot 87° cu revizie și vizor service	DN	Cod	Preț [EUR / buc]	Notă
	60 / 100	LPRKM5	90,00	
	80 / 125	LPRKM8	98,50	
	60 / 100	LPRKM5-LET	99,10	Tub interior mai lung cu 30 mm
	-	-	-	
	-	-	-	
	-	-	-	

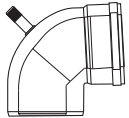
LIK cot 87° cu vizor service	DN	Cod	Preț [EUR / buc]	Notă
	60 / 100	LPBKM5	47,10	
	80 / 125	LPBKM8	49,70	
	60 / 100	LPBKM5-LET	51,80	Tub interior mai lung cu 30 mm
	80 / 125	LPBKM8-LET	54,80	Tub interior mai lung cu 30 mm
	-	-	-	
	-	-	-	

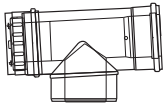
LIK teu revizie cu schimbarea direcției	DN	Cod	Preț [EUR / buc]	Notă
	60 / 100	LPUK05	46,90	
	80 / 125	LPUK08	58,30	
	60 / 100	LPUK05-LET	51,60	Tub interior mai lung cu 30 mm
	80 / 125	LPUK08-LET	64,20	Tub interior mai lung cu 30 mm
	-	-	-	
	-	-	-	

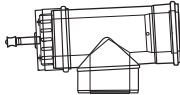
LIK teu revizie cu schimbarea direcției și vizor service	DN	Cod	Preț [EUR / buc]	Notă
	60 / 100	LPUMK5	62,60	
	80 / 125	LPUMK8	67,70	
	60 / 100	LPUMK5-LET	68,90	Tub interior mai lung cu 30 mm
	80 / 125	LPUMK8-LET	74,60	Tub interior mai lung cu 30 mm
	-	-	-	
	-	-	-	

SISTEM CONCENTRIC INTERN AER-GAZE ARSE
DN 60 / 100 și DN 80 / 125 mm

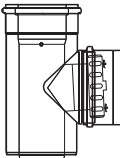
LIK teu revizie	DN	Cod	Preț [EUR / buc]	Notă
	60 / 100	LPRTK5	48,30	
	80 / 125	LPRTK8	68,30	
	-	-	-	
	-	-	-	
	-	-	-	

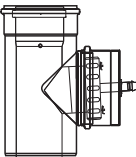
LIK teu revizie cu vizor service	DN	Cod	Preț [EUR / buc]	Notă
	60 / 100	LPRMK5	58,30	
	80 / 125	LPRMK8	76,10	
	-	-	-	
	-	-	-	
	-	-	-	

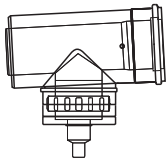
LIK teu revizie cu colector condens	DN	Cod	Preț [EUR / buc]	Notă
	60 / 100	LPRKA5	59,30	
	80 / 125	LPRKA8	69,50	
	-	-	-	
	-	-	-	
	-	-	-	

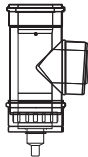
LIK teu revizie cu colector condens cu schimbarea direcției	DN	Cod	Preț [EUR / buc]	Notă
	60 / 100	LPUKA5	56,50	
	80 / 125	LPUKA8	69,50	
	-	-	-	
	-	-	-	
	-	-	-	

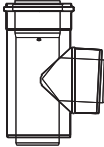
LIK teu racordare	DN	Cod	Preț [EUR / buc]	Notă
	60 / 100	LPVTK5	43,80	
	80 / 125	LPVTK8	54,80	
	-	-	-	
	-	-	-	
	-	-	-	

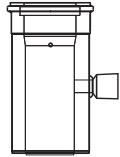
LIK tub cu scurgere condens	DN	Cod	Preț [EUR / buc]	Notă
	60 / 100	LPKFK5	42,60	Pentru instalare orizontală și verticală
	80 / 125	LPKFK8	52,80	
	-	-	-	
	-	-	-	
	-	-	-	

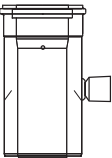
LIK tub scurgere condens pe tubulatura aspirație	DN	Cod	Preț [EUR / buc]	Notă
	60 / 100	LPKOK5	44,40	Pentru instalare orizontală și verticală
	80 / 125	LPKOK8	56,10	
	-	-	-	
	-	-	-	
	-	-	-	

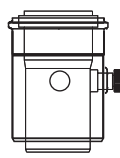
LIK tub cu 2 vizori service	DN	Cod	Preț [EUR / buc]	Notă
	60 / 100	LPMSK5	36,30	
	80 / 125	LPMSK8	48,30	
	60 / 100	LPMSK5-LET	40,00	Tub interior mai lung cu 30 mm
	80 / 125	LPMSK8-LET	53,20	Tub interior mai lung cu 30 mm
	-	-	-	
	-	-	-	

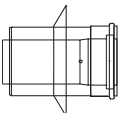
LIK tub cu inel decorativ	DN	Cod	Preț [EUR / buc]	Notă
	60 / 100	LPSAK5	21,60	
	80 / 125	LPSAK8	29,30	
	-	-	-	
	-	-	-	
	-	-	-	

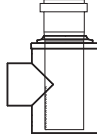
LIK teu pentru admisie aer	DN	Cod	Preț [EUR / buc]	Notă
	60 / 100	LPZTK5	46,90	Gaze arse DN60 (cu mufă), admisie aer DN80 (fără mufă).
	-	-	-	
	-	-	-	
	60-80 / 100	LPZK58	74,00	Gaze arse DN80 (cu mufă), admisie aer DN80 (fără mufă).
	60-80 / 100	LPZK58-LET	81,20	
	-	-	-	
	80 / 125	LPZTK8	55,10	Gaze arse DN80 (cu mufă), admisie aer DN80 (fără mufă).

LIL colier fixare	DN	Cod	Preț [EUR / buc]	Notă
	60 / 100	LPWHL5	34,20	La montarea colierului pe perete colierul se fixe în direcția verticală. De asemenea, potrivit pentru montarea sub tavan.
	80 / 125	LPWHL8	35,00	
	-	-	-	
	-	-	-	
	-	-	-	

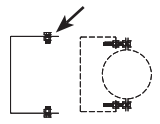
LIL prelungitor p/colier fixare I	DN	Cod	Preț [EUR / buc]	Notă
	60 / 100	LPV1L5	17,30	Numai colier fara prelungitor pentru colier
	80 / 125	LPV1L8	17,90	
	-	-	-	
	-	-	-	
	-	-	-	

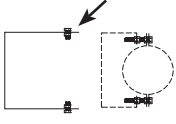
LIL prelungitor p/colier fixare II	DN	Cod	Preț [EUR / buc]	Notă
	60 / 100	LPV2L5	28,50	Numai colier fara prelungitor pentru colier
	80 / 125	LPV2L8	29,50	
	-	-	-	
	-	-	-	
	-	-	-	

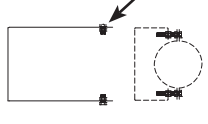
LIL prelungitor p/colier fixare III	DN	Cod	Preț [EUR / buc]	Notă
	60 / 100	LPV3L5	33,40	Numai colier fara prelungitor pentru colier
	80 / 125	LPV3L8	34,40	
	-	-	-	
	-	-	-	
	-	-	-	

ZUB inel mascare	DN	Cod	Preț [EUR / buc]	Notă
	100	UPRKW5	4,20	Alb
	100	UPRKS5	4,20	Negru, UV stabil
	125	UPRKW8	6,10	Alb
	125	UPRKS8	6,10	Negru, UV stabil

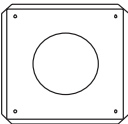
LIL plăcuță decorativă	DN	Cod	Preț [EUR / buc]	Notă
	60 / 100	LPWL05	15,50	
	80 / 125	LPWL08	15,90	
	-	-	-	
	-	-	-	
	-	-	-	

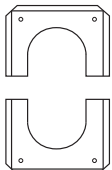
LIL plăcuță decorativă din două piese	DN	Cod	Preț [EUR / buc]	Notă
	60 / 100	LPW2L5	16,90	
	80 / 125	LPW2L8	17,30	
	-	-	-	
	-	-	-	
	-	-	-	

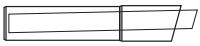
LIK tub pentru fasada	DN	Cod	Preț [EUR / buc]	Notă		
	0,55 m	60 / 100	LPASK5	44,60	Partea exterioara 0.2m UV stabilă	
		80 / 125	LPASK8	59,50		
	1,05 m	-	-	-		
		-	-	-		
		60 / 100	LPALK5	55,70		
		80 / 125	LPALK8	71,60		

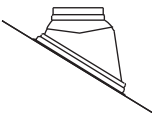
ZUB trecere acoperis 25°-45° UNI	DN	Cod	Preț [EUR / buc]	Notă	
	25-45°	60 / 100 - 80 / 125	ZUD22S	49,30	neagra
		110 / 160	ZUD26S	80,20	
	25-45°	60 / 100 - 80 / 125	ZUD22T	49,30	teracota
		110 / 160	ZUD26T	80,20	

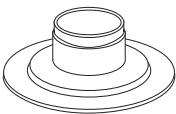
ZUB trecere acoperis - drept	DN	Cod	Preț [EUR / buc]	Notă
	60 / 100 - 80 / 125	ALPP35	26,30	Negru, UV stabil
	-	-	-	
	-	-	-	
	-	-	-	

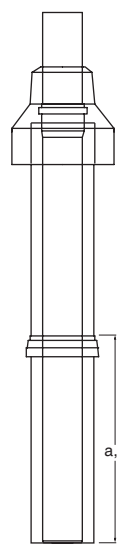
ZUB tub acoperis reglabil (set)	DN	Cod	Preț [EUR / buc]	Notă	
	1,10 m	60 / 100	DPDS45-V	75,50	Plastic, negru a = 0,15-0,6 m
		80 / 125	DPDS48-V	78,90	
		110 / 160	DPDS41-V	99,70	
		-	-	-	
	1,10 m	60 / 100	DPDT45-V	75,50	Plastic, teracota a = 0,15-0,6 m
		80 / 125	DPDT48-V	78,90	
		110 / 160	DPDT41-V	99,70	
		-	-	-	
	1,60 m	60 / 100	DPDS15-V	112,20	Plastic, negru b = 0,15-1,1 m
		80 / 125	DPDS18-V	115,10	
		110 / 160	DPDS11-V	135,50	
		-	-	-	
1,60 m	60 / 100	DPDT15-V	112,20	Plastic, teracota b = 0,15-1,1 m	
	80 / 125	DPDT18-V	115,10		
	110 / 160	DPDT11-V	135,50		
	-	-	-		

SISTEM CONCENTRIC INTERN AER-GAZE ARSE

DN 60 / 100 și DN 80 / 125 mm

LIK reducere centrala	DN	Cod	Preț [EUR / buc]	Notă	
 Alte dimensiuni la cerere	Tub DN 60 / 100	63 / 96	LPKK51	47,90	
		70 / 110	LPKK52	61,60	
		80 / 110	LPKK53	40,40	
		80 / 126	LPKK54	41,80	
	Tub DN 80 / 125	60 / 100	LPKK01	30,20	
		63 / 96	LPKK02	89,90	
		70 / 100	LPKK03	89,10	
		70 / 110	LPKK85	89,10	
		80 / 110	LPKK81	46,90	
		80 / 122	LPKK04	67,90	
		80 / 126	LPKK83	67,90	
		80 / 130	LPKK84	67,90	
		100 / 150	LPKK82	109,90	
		60 / 100	LPKK01-LET	45,30	Tub interior mai lung cu 30 mm

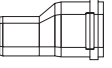
LIK reducere excentrică	DN	Cod	Preț [EUR / buc]	Notă	
	Tub 80/125	60/100	LPXK58	49,70	
		-	-	-	
		-	-	-	
		-	-	-	

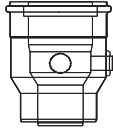
LIK reducere centrala cu 2 vizori service	DN	Cod	Preț [EUR / buc]	Notă	
 Alte dimensiuni la cerere	Tub DN 60 / 100	63 / 96	LPMK51	75,10	
		70 / 110	LPMK52	89,10	
		80 / 110	LPMK53	74,80	
		80 / 126	LPMK54	75,50	
	Tub DN 80 / 125	60 / 100	LPMK81	72,00	
		63 / 96	LPMK82	97,70	
		70 / 110	LPMK83	92,20	
		80 / 110	LPMK84	64,20	
		80 / 126	LPMK85	65,30	
		80 / 130	LPMK86	66,50	
60 / 100	LPMK81-LET	79,30	Tub interior mai lung cu 30 mm		

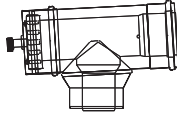
LIK teu revizie redus cu schimbarea direcției și vizor service	DN	Cod	Preț [EUR / buc]	Notă	
 Alte dimensiuni la cerere	Tub DN 60 / 100	63 / 96	LPTK51	83,80	
		70 / 110	LPTK52	98,10	
		80 / 110	LPTK53	83,00	
		80 / 126	LPTK54	88,10	
	Tub DN 80 / 125	60 / 100	LPTK81	94,40	
		63 / 96	LPTK82	124,20	
		70 / 110	LPTK83	118,70	
		80 / 110	LPTK84	80,20	
		80 / 126	LPTK85	101,20	
		80 / 130	LPTK86	103,60	
		60 / 100	LPTK81-LET	104,00	Tub interior mai lung cu 30 mm

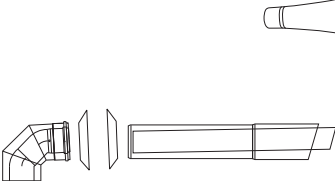
Set evacuare fum fasad LIK	DN	Cod	Cod set	Preț [EUR / buc]	Notă
	60 / 100	-	SETKW5	84,80	
	Conține:				
	60 / 100	LPALK5	LIK tub pentru fasada 1,05 m		1x
	60 / 100	UPRKS5	ZUB inel mascare – (UV stabil, negru)		1x
	60 / 100	UPRKW5	ZUB inel mascare (alb)		1x
	60 / 100	LPBK95	LIK cot 87°		1x
	-	ZUSF05	ZUB lubrifiant siliconic 50 g		1x
	80 / 125	-	SETKW8	113,40	
	Conține:				
	80 / 125	LPALK8	LIK tub pentru fasada 1,05 m		1x
	80 / 125	UPRKS8	ZUB inel mascare – (UV stabil, negru)		1x
	80 / 125	UPRKW8	ZUB inel mascare (alb)		1x
	80 / 125	LPBK98	LIK cot 87°		1x
	-	ZUSF05	ZUB lubrifiant siliconic 50 g		1x

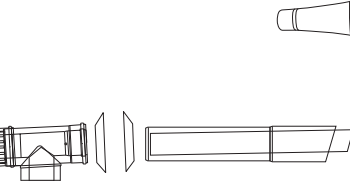
Set evacuare fum fasad cu revizie LIK	DN	Cod	Cod set	Preț [EUR / buc]	Notă
 Notă : Lungimea de bază 1,05 m setului poate fi extinsă cu tub LIK cu mufă la diametrul necesar.	60 / 100	-	SETKR5	108,10	
	Conține:				
	60 / 100	LPALK5	LIK tub pentru fasada 1,05 m		1x
	60 / 100	UPRKS5	ZUB inel mascare – (UV stabil, negru)		1x
	60 / 100	UPRKW5	ZUB inel mascare (alb)		1x
	60 / 100	LPUK05	LIK teu revizie cu schimbarea direcției		1x
	-	ZUSF05	ZUB lubrifiant siliconic 50 g		1x
	80 / 125	-	SETKR8	137,70	
	Conține:				
	80 / 125	LPALK8	LIK tub pentru fasada 1,05 m		1x
	80 / 125	UPRKS8	ZUB inel mascare – (UV stabil, negru)		1x
	80 / 125	UPRKW8	ZUB inel mascare (alb)		1x
	80 / 125	LPUK08	LIK teu revizie cu schimbarea direcției		1x
	-	ZUSF05	ZUB lubrifiant siliconic 50 g		1x

LIL, LIB

LIL – PPH/inox-komaxit alb, LIB – PPH/inox

SISTEM CONCENTRIC INTERN AER-GAZE ARSE
DN 60 / 100 – DN 200 / 300 mm

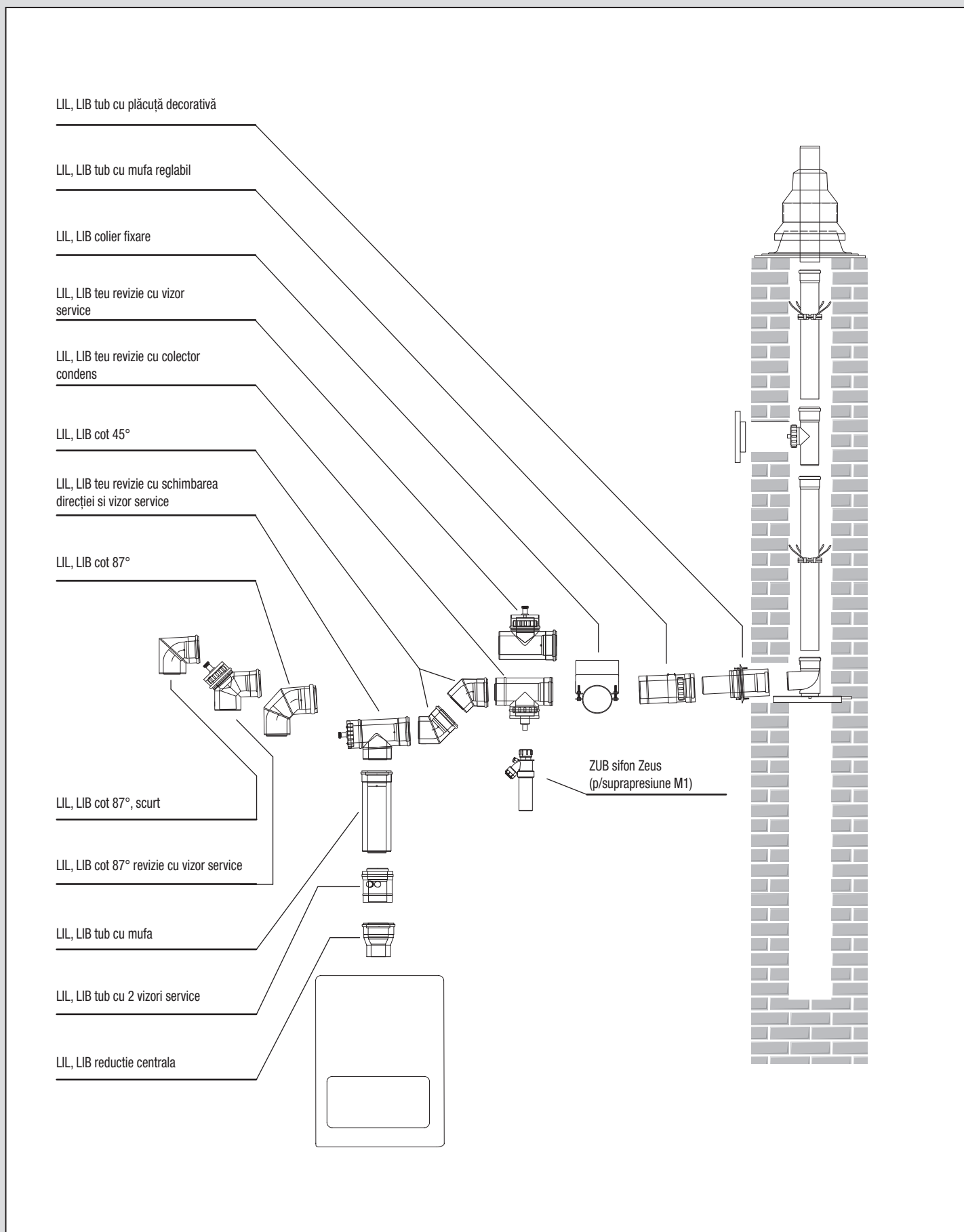



SISTEM CONCENTRIC INTERN AER-GAZE ARSE
DN 60 / 100 – DN 200 / 300 mm

LIL

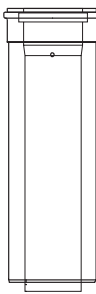
PPH/inox-komaxit alb

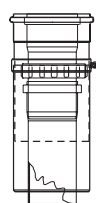
LIL tub cu mufa	DN	Cod	Preț [EUR / buc]	Notă	
	0,25 m	60 / 100	LPRL05	23,80	
		80 / 125	LPRL08	26,90	
		110 / 160	LPRL01	37,30	
		125 / 180	LPRL02	45,00	
		160 / 225	LPRL06	54,40	
		200 / 300	LPRL00	96,70	
	0,50 m	60 / 100	LPRL55	34,80	
		80 / 125	LPRL58	37,70	
		110 / 160	LPRL51	52,80	
		125 / 180	LPRL52	63,00	
		160 / 225	LPRL56	79,10	
		200 / 300	LPRL50	123,60	
	1,00 m	60 / 100	LPRL15	51,60	
		80 / 125	LPRL18	59,90	
		110 / 160	LPRL11	79,70	
		125 / 180	LPRL12	98,10	
		160 / 225	LPRL16	131,80	
		200 / 300	LPRL10	173,40	

LIL tub cu mufa reglabil	DN	Cod	Preț [EUR / buc]	Notă	
	0,20 - 0,32 m	60 / 100	LPSL25	61,20	
		80 / 125	LPSL28	62,40	
		110 / 160	LPSL21	89,70	
		125 / 180	LPSL22	96,50	
		160 / 225	LPSL26	136,30	
		200 / 300	LPSL20	213,60	
	0,29 - 0,50 m	60 / 100	LPSL55	69,50	
		80 / 125	LPSL58	69,90	
		110 / 160	LPSL51	101,40	
		125 / 180	LPSL52	109,90	
		160 / 225	LPSL56	153,80	
		200 / 300	LPSL50	241,60	

LIL cot 15°	DN	Cod	Preț [EUR / buc]	Notă
	60 / 100	LPBL15	38,70	
	80 / 125	LPBL18	42,60	
	110 / 160	LPBL11	55,30	
	125 / 180	LPBL12	64,40	
	160 / 225	LPBL16	86,70	
	200 / 300	LPBL10	117,70	

LIL cot 30°	DN	Cod	Preț [EUR / buc]	Notă
	60 / 100	LPBL35	35,90	
	80 / 125	LPBL38	43,20	
	110 / 160	LPBL31	54,60	
	125 / 180	LPBL32	63,00	
	160 / 225	LPBL36	86,10	
	200 / 300	LPBL30	121,00	

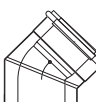
LIL cot 45°	DN	Cod	Preț [EUR / buc]	Notă
	60 / 100	LPBL45	34,20	
	80 / 125	LPBL48	38,10	
	110 / 160	LPBL41	49,30	
	125 / 180	LPBL42	61,20	
	160 / 225	LPBL46	83,20	
	200 / 300	LPBL40	122,20	

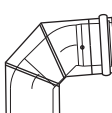
LIL cot 87°	DN	Cod	Preț [EUR / buc]	Notă
	60 / 100	LPBL95	60,40	
	80 / 125	LPBL98	63,60	
	110 / 160	LPBL91	78,50	
	125 / 180	LPBL92	98,50	
	160 / 225	LPBL96	110,00	
	200 / 300	LPBL90	171,40	

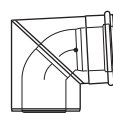
LIL cot 87°, scurt	DN	Cod	Preț [EUR / buc]	Notă
	60 / 100	LPBLK5	51,00	
	80 / 125	LPBLK8	54,20	
	110 / 160	LPBLK1	63,20	
	125 / 180	LPBLK2	77,90	
	160 / 225	LPBLK6	101,00	
	200 / 300	LPBLK0	149,10	

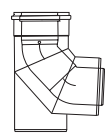
LIL cot 87° cu suport	DN	Cod	Preț [EUR / buc]	Notă
	60 / 100	LPSBL5	84,80	
	80 / 125	LPSBL8	92,80	
	110 / 160	LPSBL1	117,90	
	125 / 180	LPSBL2	147,50	
	160 / 225	LPSBL6	157,50	
	200 / 300	LPSBL0	242,00	

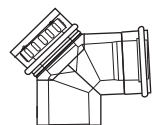
LIL cot 87° cu revizie	DN	Cod	Preț [EUR / buc]	Notă
	60 / 100	LPRBL5	96,90	
	80 / 125	LPRBL8	101,00	
	110 / 160	LPRBL1	150,80	
	125 / 180	LPRBL2	168,70	
	160 / 225	LPRBL6	183,80	
	200 / 300	LPRBL0	241,00	

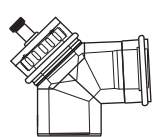
LIL cot 87° cu revizie și vizor service	DN	Cod	Preț [EUR / buc]	Notă
	60 / 100	LPRLM5	113,00	
	80 / 125	LPRLM8	114,20	
	110 / 160	LPRLM1	171,00	
	125 / 180	LPRLM2	184,80	
	160 / 225	LPRLM6	208,50	
	200 / 300	LPRLM0	276,70	

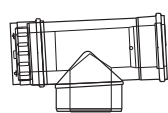
LIL teu revizie cu schimbarea direcției	DN	Cod	Preț [EUR / buc]	Notă
	60 / 100	LPUL05	69,90	
	80 / 125	LPUL08	78,30	
	110 / 160	LPUL01	125,70	
	125 / 180	LPUL02	143,80	
	160 / 225	LPUL06	163,60	
	200 / 300	LPUL00	243,80	
	60 / 100	LPUL05-LET	79,10	Tub interior mai lung cu 30 mm

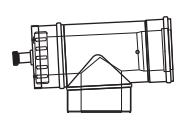
LIL teu revizie cu schimbarea direcției și vizor service	DN	Cod	Preț [EUR / buc]	Notă
	60 / 100	LPUML5	81,00	
	80 / 125	LPUML8	88,50	
	110 / 160	LPUML1	139,10	
	125 / 180	LPUML2	157,10	
	160 / 225	LPUML6	185,00	
	200 / 300	LPUML0	266,90	

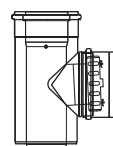
LIL teu revizie	DN	Cod	Preț [EUR / buc]	Notă
	60 / 100	LPRTL5	71,00	
	80 / 125	LPRTL8	80,40	
	110 / 160	LPRTL1	118,50	
	125 / 180	LPRTL2	145,50	
	160 / 225	LPRTL6	159,10	
	200 / 300	LPRTL0	204,00	

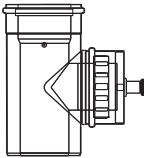
LIL teu revizie cu vizor service	DN	Cod	Preț [EUR / buc]	Notă
	60 / 100	LPRML5	85,70	
	80 / 125	LPRML8	94,60	
	110 / 160	LPRML1	139,50	
	125 / 180	LPRML2	158,50	
	160 / 225	LPRML6	181,80	
	200 / 300	LPRML0	232,00	

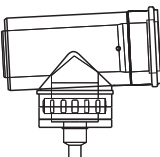
LIL teu revizie cu colector condens	DN	Cod	Preț [EUR / buc]	Notă
	60 / 100	LPRLA5	85,00	
	80 / 125	LPRLA8	87,10	
	110 / 160	LPRLA1	130,60	
	125 / 180	LPRLA2	147,50	
	160 / 225	LPRLA6	165,70	
	200 / 300	LPRLA0	232,00	

LIL teu revizie cu colector condens și schimbarea direcției	DN	Cod	Preț [EUR / buc]	Notă
	60 / 100	LPULA5	83,80	
	80 / 125	LPULA8	84,40	
	110 / 160	LPULA1	130,60	
	125 / 180	LPULA2	147,70	
	160 / 225	LPULA6	178,90	
	200 / 300	LPULA0	262,40	

LIL teu racord	DN	Cod	Preț [EUR / buc]	Notă
	60 / 100	LPVTL5	59,30	
	80 / 125	LPVTL8	59,50	
	110 / 160	LPVTL1	72,60	
	125 / 180	LPVTL2	89,10	
	160 / 225	LPVTL6	107,70	
	200 / 300	LPVTL0	180,60	

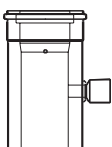
LIL tub cu scurgere condens	DN	Cod	Preț [EUR / buc]	Notă
	60 / 100	LPKFL5	55,10	Pentru instalare orizontală și verticală
	80 / 125	LPKFL8	56,90	
	110 / 160	LPKFL1	64,40	
	125 / 180	LPKFL2	75,10	
	160 / 225	LPKFL6	87,10	
	200 / 300	LPKFL0	124,40	

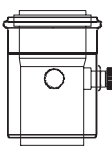
LIL tub cu 2 vizori service	DN	Cod	Preț [EUR / buc]	Notă
	60 / 100	LPMSL5	39,90	
	80 / 125	LPMSL8	42,60	
	110 / 160	LPMSL1	55,50	
	125 / 180	LPMSL2	65,90	
	160 / 225	LPMSL6	71,40	
	200 / 300	LPMSL0	107,90	
	60 / 100	LPMSL5-LET	43,80	Tub interior mai lung cu 30 mm

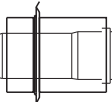
LIL tub cu plăcuță decorativă	DN	Cod	Preț [EUR / buc]	Notă
	60 / 100	LPSAL5	22,40	
	80 / 125	LPSAL8	24,40	
	110 / 160	LPSAL1	28,50	
	125 / 180	LPSAL2	34,40	
	160 / 225	LPSAL6	45,10	
	200 / 300	LPSAL0	80,60	

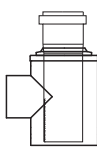
LIL teu aspirarea aer	DN	Cod	Preț [EUR / buc]	Notă
	60 / 100	LPZTL5	51,40	
	80 / 125	LPZTL8	59,30	
	110 / 160	LPZTL1	65,30	
	125 / 180	LPZTL2	82,40	
	160 / 225	LPZTL6	92,60	
	200 / 300	LPZTL0	110,40	

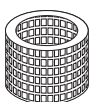
LIL coș aspirarea aer	DN	Cod	Preț [EUR / buc]	Notă
	60 / 100	LPAKL5	38,10	
	80 / 125	LPAKL8	38,50	
	110 / 160	LPAKL1	48,10	
	125 / 180	LPAKL2	55,10	
	160 / 225	LPAKL6	62,00	
	200 / 300	LPAKL0	69,50	

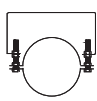
LIL colier fixare	DN	Cod	Preț [EUR / buc]	Notă
	60 / 100	LPWHL5	34,20	La montarea colierului pe perete colierul se fie în direcția verticală. De asemenea, potrivit pentru montarea sub tavan.
	80 / 125	LPWHL8	35,00	
	110 / 160	LPWHL1	37,70	
	125 / 180	LPWHL2	43,00	
	160 / 225	LPWHL6	50,60	
	200 / 300	LPWHL0	58,70	

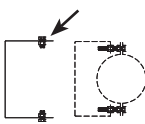
LIL prelungitor p/colier fixare I	DN	Cod	Preț [EUR / buc]	Notă
	60 / 100	LPV1L5	17,30	Numai colier fara prelungitor pentru colier
	80 / 125	LPV1L8	17,90	
	110 / 160	LPV1L1	18,10	
	125 / 180	LPV1L2	20,40	
	160 / 225	LPV1L6	22,40	
	200 / 300	LPV1L0	24,80	

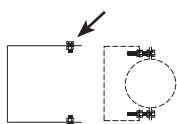
LIL prelungitor p/colier fixare II	DN	Cod	Preț [EUR / buc]	Notă
	60 / 100	LPV2L5	28,50	Numai colier fara prelungitor pentru colier
	80 / 125	LPV2L8	29,50	
	110 / 160	LPV2L1	29,90	
	125 / 180	LPV2L2	30,20	
	160 / 225	LPV2L6	32,80	
	200 / 300	LPV2L0	35,00	

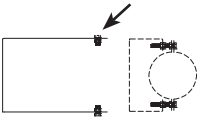
LIL prelungitor p/colier fixare III	DN	Cod	Preț [EUR / buc]	Notă
	60 / 100	LPV3L5	33,40	Numai colier fara prelungitor pentru colier
	80 / 125	LPV3L8	34,40	
	110 / 160	LPV3L1	35,00	
	125 / 180	LPV3L2	35,30	
	160 / 225	LPV3L6	36,10	
	200 / 300	LPV3L0	39,50	

SISTEM CONCENTRIC INTERN AER-GAZE ARSE
DN 60 / 100 – DN 200 / 300 mm

ZUB inel mascare	DN	Cod	Preț [EUR / buc]	Notă
	100	UPRKW5	4,20	Alb
	100	UPRK55	4,20	Negru, UV stabil
	125	UPRKW8	6,10	Alb
	125	UPRKS8	6,10	Negru, UV stabil

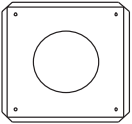
LIL plăcuță decorativă	DN	Cod	Preț [EUR / buc]	Notă
	60 / 100	LPWL05	15,50	
	80 / 125	LPWL08	15,90	
	110 / 160	LPWL01	16,30	
	125 / 180	LPWL02	16,70	
	160 / 225	LPWL06	20,80	
	200 / 300	LPWL00	22,00	

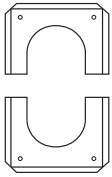
LIL plăcuță decorativă din două piese	DN	Cod	Preț [EUR / buc]	Notă
	60 / 100	LPW2L5	16,90	
	80 / 125	LPW2L8	17,30	
	110 / 160	LPW2L1	18,70	
	125 / 180	LPW2L2	20,40	
	160 / 225	LPW2L6	23,20	
	200 / 300	LPW2L0	28,10	

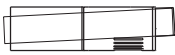
LIL tubulatura pentru fasada	DN	Cod	Preț [EUR / buc]	Notă
	60 / 100	APASL5	67,30	
	80 / 125	APASL8	67,50	
	110 / 160	APASL1	97,30	
	125 / 180	APASL2	102,40	
	160 / 225	APASL6	120,80	
	200 / 300	APASL0	165,70	

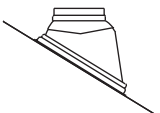
ZUB trecere acoperis 25°-45° UNI	DN	Cod	Preț [EUR / buc]	Notă
	60 / 100 - 80 / 125	ZUD22S	49,30	neagra
	110 / 160	ZUD26S	80,20	
	60 / 100 - 80 / 125	ZUD22T	49,30	teracota
	110 / 160	ZUD26T	80,20	

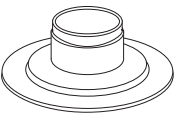
ZUB trecere acoperis - drept	DN	Cod	Preț [EUR / buc]	Notă
	60 / 100 - 80 / 125	ALPP35	26,30	Negru, UV stabil
	-	-	-	
	-	-	-	
	-	-	-	

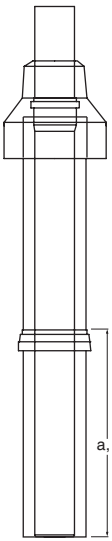
ZUB tub acoperis reglabil (set)	DN	Cod	Preț [EUR / buc]	Notă
	60 / 100	DPDS45-V	75,50	Plastic, negru a = 0,15-0,6 m
	80 / 125	DPDS48-V	78,90	
	110 / 160	DPDS41-V	99,70	
	-	-	-	
	-	-	-	
	60 / 100	DPDT45-V	75,50	Plastic, teracota a = 0,15-0,6 m
	80 / 125	DPDT48-V	78,90	
	110 / 160	DPDT41-V	99,70	
	-	-	-	
	-	-	-	
	60 / 100	DPDS15-V	112,20	Plastic, negru b = 0,15-1,1 m
	80 / 125	DPDS18-V	115,10	
110 / 160	DPDS11-V	135,50		
-	-	-		
-	-	-		
60 / 100	DPDT15-V	112,20	Plastic, teracota b = 0,15-1,1 m	
80 / 125	DPDT18-V	115,10		
110 / 160	DPDT11-V	135,50		
-	-	-		
-	-	-		

LIL reductie centrala	DN	Cod	Preț [EUR / buc]	Notă
Tub DN 60 / 100	63 / 96	LPKL51	51,00	
	70 / 110	LPKL52	65,00	
	80 / 110	LPKL53	42,40	
	80 / 126	LPKL54	41,60	
-	-	-	-	
Tub DN 80 / 125	60 / 100	LPKL01	36,90	
	63 / 96	LPKL02	58,10	
	70 / 100	LPKL03	61,20	
	70 / 110	LPKL85	58,10	
	80 / 110	LPKL81	39,90	
	80 / 122	LPKL04	44,40	
	80 / 126	LPKL83	44,80	
	80 / 130	LPKL84	45,00	
	100 / 150	LPKL82	51,40	
	110 / 160	LPKL86	54,60	
Tub DN 110 / 160	80 / 110	LPKL11	64,80	
	80 / 125	LPKL06	65,00	
	100 / 130	LPKL07	65,10	
	100 / 150	LPKL09	66,30	
	110 / 150	LPKL16	58,10	
	-	-	-	-
Tub DN 125 / 180	80 / 110	LPKL21	78,30	
	80 / 125	LPKL22	72,60	
	100 / 150	LPKL23	73,40	
	110 / 160	LPKL24	73,80	
	-	-	-	-
Tub DN 160 / 225	100 / 150	LPKL61	100,80	
	110 / 160	LPKL62	91,20	
	125 / 180	LPKL63	92,20	
	-	-	-	-
Tub DN 200 / 300	100 / 150	LPKLY1	140,40	
	110 / 160	LPKLY2	140,80	
	125 / 180	LPKLY3	141,60	
	160 / 225	LPKLY4	142,80	
	-	-	-	-
	-	-	-	-

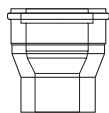

Alte dimensiuni la cerere

LIL reductie centrala - excentrică	DN	Cod	Preț [EUR / buc]	Notă
Tub DN 60 / 100	-	-	-	
	-	-	-	
	-	-	-	
	-	-	-	
	-	-	-	
Tub DN 80 / 125	60 / 100	LPKXL58	56,70	
	-	-	-	
	-	-	-	
	-	-	-	
	-	-	-	
	-	-	-	
	-	-	-	
	-	-	-	
Tub DN 110 / 160	60 / 100	LPKXL51	64,20	
	80 / 125	LPKXL81	65,70	
	-	-	-	
	-	-	-	
Tub DN 125 / 180	60 / 100	LPKXL52	74,20	
	80 / 125	LPKXL82	77,30	
	110 / 160	LPKXL12	84,60	
	-	-	-	
Tub DN 160 / 225	60 / 100	LPKXL56	100,20	
	80 / 125	LPKXL86	101,40	
	110 / 160	LPKXL16	102,00	
	125 / 180	LPKXL26	103,80	
	-	-	-	
Tub DN 200 / 300	60 / 100	LPKXL50	132,40	
	80 / 125	LPKXL80	133,80	
	110 / 160	LPKXL10	135,00	
	125 / 180	LPKXL20	136,50	
	160 / 225	LPKXL60	139,10	
	-	-	-	

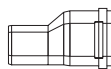

Alte dimensiuni la cerere

SISTEM CONCENTRIC INTERN AER-GAZE ARSE
DN 60 / 100 – DN 200 / 300 mm

LIL

PPH/inox-komaxit alb

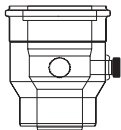
LIL reducere centrala cu 2 vizori service	DN	Cod	Preț [EUR / buc]	Notă	
 Alte dimensiuni la cerere	Tub DN 60 / 100	63 / 96	LPML51	79,10	
		70 / 110	LPML52	90,40	
		80 / 110	LPML53	79,30	
		80 / 126	LPML54	89,90	
		-	-	-	
	Tub DN 80 / 125	60 / 100	LPML81	80,20	
		63 / 96	LPML82	90,20	
		70 / 110	LPML83	101,80	
		80 / 110	LPML84	73,40	
		80 / 126	LPML85	58,90	
		80 / 130	LPML86	58,90	
		60 / 100	LPML81-LET	83,40	
	Tub DN 110 / 160	80 / 110	LPML11	91,60	
		80 / 125	LPML12	91,20	
		100 / 150	LPML13	93,00	
		-	-	-	
	Tub DN 125 / 180	80 / 110	LPML21	105,70	
		80 / 125	LPML22	105,90	
		100 / 150	LPML23	108,70	
		110 / 160	LPML24	111,00	
		-	-	-	
	Tub DN 160 / 225	100 / 150	LPML61	126,90	
		110 / 160	LPML62	127,50	
		125 / 180	LPML63	129,30	
-		-	-		
Tub DN 200 / 300	100 / 150	LPML01	134,80		
	110 / 160	LPML02	138,10		
	125 / 180	LPML03	141,20		
	160 / 225	LPML04	157,50		
	-	-	-		

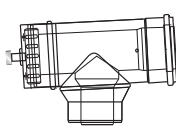
LIL teu revizie redus cu schimbarea direcției cu vizor service	DN	Cod	Preț [EUR / buc]	Notă	
 Alte dimensiuni la cerere	Tub DN 60 / 100	63 / 96	LPTL51	121,60	
		70 / 110	LPTL52	163,60	
		80 / 110	LPTL53	124,40	
		80 / 126	LPTL54	162,80	
		-	-	-	
	Tub DN 80 / 125	60 / 100	LPTL81	127,10	
		63 / 96	LPTL82	176,30	
		70 / 110	LPTL83	177,50	
		80 / 110	LPTL84	146,10	
		80 / 126	LPTL85	133,80	
		80 / 130	LPTL86	145,90	
		60 / 100	LPTL81-LET	139,90	
	Tub DN 110 / 160	80 / 110	LPTL11	162,20	
		80 / 125	LPTL12	162,20	
		100 / 150	LPTL13	162,20	
		-	-	-	
	Tub DN 125 / 180	80 / 110	LPTL21	191,20	
		80 / 125	LPTL22	194,20	
		100 / 150	LPTL23	199,70	
		110 / 160	LPTL24	192,00	
		-	-	-	
	Tub DN 160 / 225	80 / 125	LPTL60	236,10	
		100 / 150	LPTL61	234,40	
		110 / 160	LPTL62	234,00	
125 / 180		LPTL63	234,40		
Tub DN 200 / 300	80 / 125	LPTL00	266,30		
	100 / 150	LPTL01	271,60		
	110 / 160	LPTL02	276,70		
	125 / 180	LPTL03	271,20		
	160 / 225	LPTL04	290,80		

SISTEM CONCENTRIC INTERN AER-GAZE ARSE (LIB)
DN 60 / 100 – DN 200 / 300 mm

LIB
 PPH/inox

Elementele sistemului LIB sunt identice cu elementele sistemului LIL, diferind doar prin designul carcasei exterioare, care este realizat din oțel inoxidabil lustruit. Pentru comenzile LIB, litera „L” din elementul de cod trebuie înlocuită cu litera „B”, care se află întotdeauna pe poziția a 4-a sau a 5-a a codului.

Exemplu:

LIL tub cu mufa 1m 60 / 100... cod LPR**L**15 => LIB tub cu mufa 1m 60 / 100... cod LPR**B**15

Pretul este calculat pentru elementele sistemului LIL + 10% cost suplimentar

Exemplu:

LIL cot 87° 80 / 125 LPBL98... **63,60**

LIB cot 87° 80 / 125 LPBB98... 63,60 + 10% = **69,96**

Termen de livrare - până la 4 săptămâni.

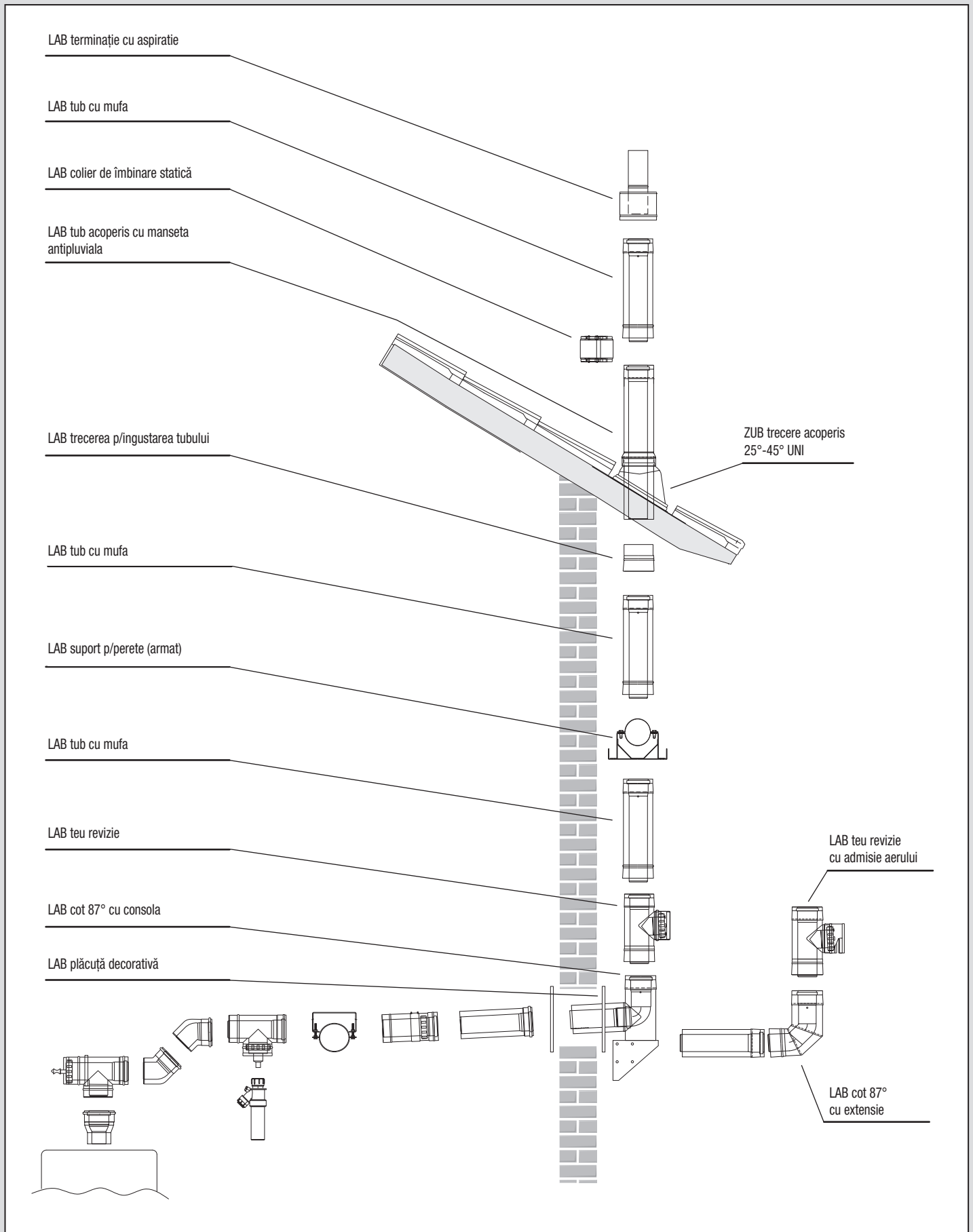

SISTEM CONCENTRIC EXTERN AER-GAZE ARSE
DN 60 / 100 – DN 200 / 300 mm

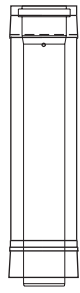
LAB tub cu mufa	DN	Cod	Preț [EUR / buc]	Notă	
	0,25 m	60 / 100	APRB05	22,80	
		80 / 125	APRB08	25,10	
		110 / 160	APRB01	32,80	
		125 / 180	APRB02	48,70	
		160 / 225	APRB06	53,80	
		200 / 300	APRB00	91,00	
	0,50 m	60 / 100	APRB55	34,00	
		80 / 125	APRB58	37,30	
		110 / 160	APRB51	48,90	
		125 / 180	APRB52	67,10	
	1,00 m	160 / 225	APRB56	77,10	
		200 / 300	APRB50	128,70	
60 / 100		APRB15	54,40		
80 / 125		APRB18	62,00		
	110 / 160	APRB11	80,60		
	125 / 180	APRB12	110,20		
	160 / 225	APRB16	130,20		
	200 / 300	APRB10	195,70		

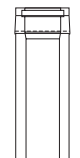
LAB tub cu mufă de tranziție 0,5m	DN	Cod	Preț [EUR / buc]	Notă	
	0,50 m	60 / 100	APRSB5	34,00	
		80 / 125	APRSB8	37,30	
		110 / 160	APRSB1	48,90	
		125 / 180	APRSB2	67,10	
		160 / 225	APRSB6	77,10	
		200 / 300	APRSB0	128,70	

LAB tub cu mufa reglabil	DN	Cod	Preț [EUR / buc]	Notă	
	0,20 - 0,32 m	60 / 100	APSB25	57,70	
		80 / 125	APSB28	59,90	
		110 / 160	APSB21	84,20	
		125 / 180	APSB22	90,60	
		160 / 225	APSB26	128,30	
		200 / 300	APSB20	200,60	
	0,29 - 0,50 m	60 / 100	APSB55	68,50	
		80 / 125	APSB58	73,20	
		110 / 160	APSB51	101,40	
		125 / 180	APSB52	109,70	
		160 / 225	APSB56	154,20	
		200 / 300	APSB50	241,00	

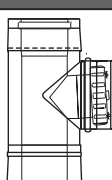
LAB teu revizie	DN	Cod	Preț [EUR / buc]	Notă
	60 / 100	APRTB5	89,30	
	80 / 125	APRTB8	92,00	
	110 / 160	APRTB1	123,40	
	125 / 180	APRTB2	137,30	
	160 / 225	APRTB6	159,70	
	200 / 300	APRTB0	219,10	

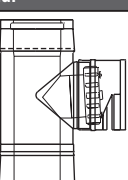
LAB teu revizie cu admisie aerului	DN	Cod	Preț [EUR / buc]	Notă
	60 / 100	APRZB5	93,40	
	80 / 125	APRZB8	95,30	
	110 / 160	APRZB1	129,70	
	125 / 180	APRZB2	139,30	
	160 / 225	APRZB6	172,60	
	200 / 300	APRZB0	226,10	

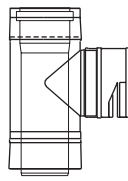
LAB teu admisie aerului	DN	Cod	Preț [EUR / buc]	Notă
	60 / 100	APTZB5	74,00	
	80 / 125	APTZB8	74,60	
	110 / 160	APTZB1	94,40	
	125 / 180	APTZB2	95,30	
	160 / 225	APTZB6	108,50	
	200 / 300	APTZB0	162,60	

LAB cot 15°	DN	Cod	Preț [EUR / buc]	Notă
	60 / 100	APBB15	38,30	
	80 / 125	APBB18	39,10	
	110 / 160	APBB11	44,40	
	125 / 180	APBB12	61,60	
	160 / 225	APBB16	74,20	
	200 / 300	APBB10	117,50	

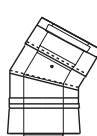
LAB cot 30°	DN	Cod	Preț [EUR / buc]	Notă
	60 / 100	APBB35	39,10	
	80 / 125	APBB38	39,90	
	110 / 160	APBB31	44,80	
	125 / 180	APBB32	62,60	
	160 / 225	APBB36	75,10	
	200 / 300	APBB30	118,90	

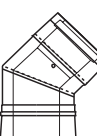
LAB cot 45°	DN	Cod	Preț [EUR / buc]	Notă
	60 / 100	APBB45	35,50	
	80 / 125	APBB48	39,30	
	110 / 160	APBB41	46,50	
	125 / 180	APBB42	66,30	
	160 / 225	APBB46	77,70	
	200 / 300	APBB40	120,20	

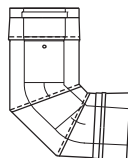
LAB cot 87°	DN	Cod	Preț [EUR / buc]	Notă
	60 / 100	APBB95	55,00	
	80 / 125	APBB98	61,20	
	110 / 160	APBB91	73,00	
	125 / 180	APBB92	88,90	
	160 / 225	APBB96	111,80	
	200 / 300	APBB90	167,10	

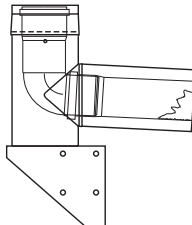
LAB cot 87° cu consola	DN	Cod	Preț [EUR / buc]	Notă
	60 / 100	APWKB5	139,10	Distanța coș de la fasada 50 mm
	80 / 125	APWKB8	157,90	
	110 / 160	APWKB1	169,30	
	125 / 180	APWKB2	184,80	
	160 / 225	APWKB6	218,30	
	200 / 300	APWKB0	355,90	
	-	-	-	
	-	-	-	

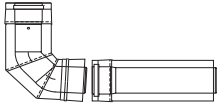
LAB cot 87° cu tub 0,5m	DN	Cod	Preț [EUR / buc]	Notă
	60 / 100	APSBB5	88,90	0,50 m
	80 / 125	APSBB8	98,50	
	110 / 160	APSBB1	121,80	
	125 / 180	APSBB2	155,90	
	160 / 225	APSBB6	188,90	
	200 / 300	APSBB0	295,70	

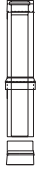
LAB tub acoperis cu manșeta antipluvială	DN	Cod	Preț [EUR / buc]	Notă
	60 / 100	APDA45	97,30	0,40 m deasupra acoperișului
	80 / 125	APDA48	99,90	
	110 / 160	APDA41	111,60	
	125 / 180	APDA42	145,10	
	160 / 225	APDA46	157,70	
	200 / 300	APDA40	218,30	

LAB trecerea p/îngustarea tubului	DN	Cod	Preț [EUR / buc]	Notă
	60 / 100	APMKB5	12,20	
	80 / 125	APMKB8	14,00	
	110 / 160	APMKB1	15,10	
	125 / 180	APMKB2	16,90	
	160 / 225	APMKB6	18,30	
	200 / 300	APMKB0	20,80	

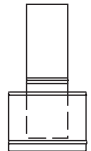
LAB terminație cu aspirație	DN	Cod	Preț [EUR / buc]	Notă
	60 / 100	APMSB5	63,20	
	80 / 125	APMSB8	65,70	
	110 / 160	APMSB1	69,30	
	125 / 180	APMSB2	78,10	
	160 / 225	APMSB6	88,90	
	200 / 300	APMSB0	125,70	

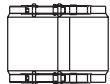
LAB colier de îmbinare statică	DN	Cod	Preț [EUR / buc]	Notă
	60 / 100	APKLB5	27,70	
	80 / 125	APKLB8	29,50	
	110 / 160	APKLB1	34,60	
	125 / 180	APKLB2	35,30	
	160 / 225	APKLB6	37,50	
	200 / 300	APKLB0	41,60	

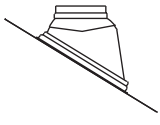
ZUB trecere acoperis 25°-45° UNI	DN	Cod	Preț [EUR / buc]	Notă
	60 / 100 - 80 / 125	ZUD22S	49,30	neagra
	110 / 160	ZUD26S	80,20	
	-	-	-	
	60 / 100 - 80 / 125	ZUD22T	49,30	teracota
	110 / 160	ZUD26T	80,20	
	-	-	-	

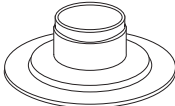
ZUB trecere acoperis - drept	DN	Cod	Preț [EUR / buc]	Notă
	60 / 100 - 80 / 125	ALPP35	26,30	Negru, UV stabil
	-	-	-	
	-	-	-	
	-	-	-	

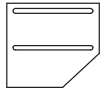
LAB consola de descarcare reglabila I	DN	Cod	Preț [EUR / buc]	Notă
	60 / 100	APW1B5	46,90	50-210 mm
	80 / 125	APW1B8	49,10	50-150 mm
	110 / 160	APW1B1	55,70	50-205 mm
	125 / 180	APW1B2	60,00	50-270 mm
	160 / 225	APW1B6	70,60	-
	200 / 300	APW1B0	93,60	-

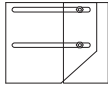
LAB consola de descarcare reglabila II	DN	Cod	Preț [EUR / buc]	Notă
	60 / 100	APW2B5	77,70	150-295 mm
	80 / 125	APW2B8	83,00	150-235 mm
	110 / 160	APW2B1	90,20	170-235 mm
	125 / 180	APW2B2	94,80	-
	160 / 225	APW2B6	109,90	-
	200 / 300	APW2B0	141,40	-

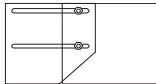
LAB consola de descarcare reglabila III	DN	Cod	Preț [EUR / buc]	Notă
	60 / 100	APW3B5	94,20	230-330 mm
	80 / 125	APW3B8	98,90	230-330 mm
	110 / 160	APW3B1	109,50	230-330 mm
	125 / 180	APW3B2	114,20	225-390 mm
	160 / 225	APW3B6	127,50	-
	200 / 300	APW3B0	163,60	-

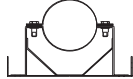
LAB suport p/perete (armat)	DN	Cod	Preț [EUR / buc]	Notă
	60 / 100	APWHB5	41,80	Distanța coș de la fasada 50 mm
	80 / 125	APWHB8	45,90	
	110 / 160	APWHB1	50,40	
	125 / 180	APWHB2	53,00	
	160 / 225	APWHB6	57,10	
	200 / 300	APWHB0	71,00	

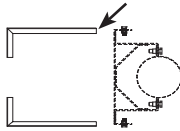
LAB prelungitor suport p/perete (armat)	DN	Cod	Preț [EUR / buc]	Notă
	60 / 100	APVUBU	57,30	Distanța coș de la fasada 50-350 mm
	80 / 125	APVUBU	57,30	
	110 / 160	APVUBU	57,30	
	125 / 180	APVUBU	57,30	
	160 / 225	APVUBU	57,30	
	200 / 300	APVUBU	57,30	

Singura extensie fără colier

SISTEM CONCENTRIC EXTERN AER-GAZE ARSE
DN 60 / 100 – DN 200 / 300 mm

LAB
 PPH/inox

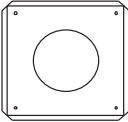
LAB plăcuță decorativă	DN	Cod	Preț [EUR / buc]	Notă
	60 / 100	LPWB05	17,10	
	80 / 125	LPWB08	17,50	
	110 / 160	LPWB01	18,00	
	125 / 180	LPWB02	18,40	
	160 / 225	LPWB06	22,90	
	200 / 300	LPWB00	24,20	

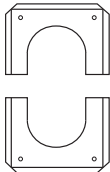
LAB plăcuță decorativă din două piese	DN	Cod	Preț [EUR / buc]	Notă
	60 / 100	LPW2B5	18,60	
	80 / 125	LPW2B8	19,00	
	110 / 160	LPW2B1	20,60	
	125 / 180	LPW2B2	22,50	
	160 / 225	LPW2B6	25,50	
	200 / 300	LPW2B0	30,90	

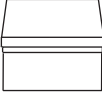
Trecere LIB la LAB	DN	Cod	Preț [EUR / buc]	Notă
	60 / 100	APSKB5	17,30	
	80 / 125	APSKB8	19,30	
	110 / 160	APSKB1	22,80	
	125 / 180	APSKB2	28,30	
	160 / 225	APSKB6	34,20	
	200 / 300	APSKB0	63,60	

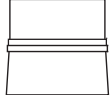
Trecere LAB la LIB	DN	Cod	Preț [EUR / buc]	Notă
	60 / 100	APDMB5	12,80	
	80 / 125	APDMB8	14,80	
	110 / 160	APDMB1	15,90	
	-	-	-	
	-	-	-	
	-	-	-	



Sistemul LAB poate fi comandat și într-o versiune color, în conformitate cu specimenul RAL.

Vopseaua se aplică utilizând tehnologia de acoperire cu pulbere (komaxitație).

Prețul este calculat pentru elementele sistemului LAB + suprataxă de vopsire 30%

Termen de livrare a elementelor vopsite suplimentar:

DN 60/100 - DN 110/160 în termen de 2 săptămâni

DN 125 / 180 - DN 200 / 300 în termen de 4 săptămâni.

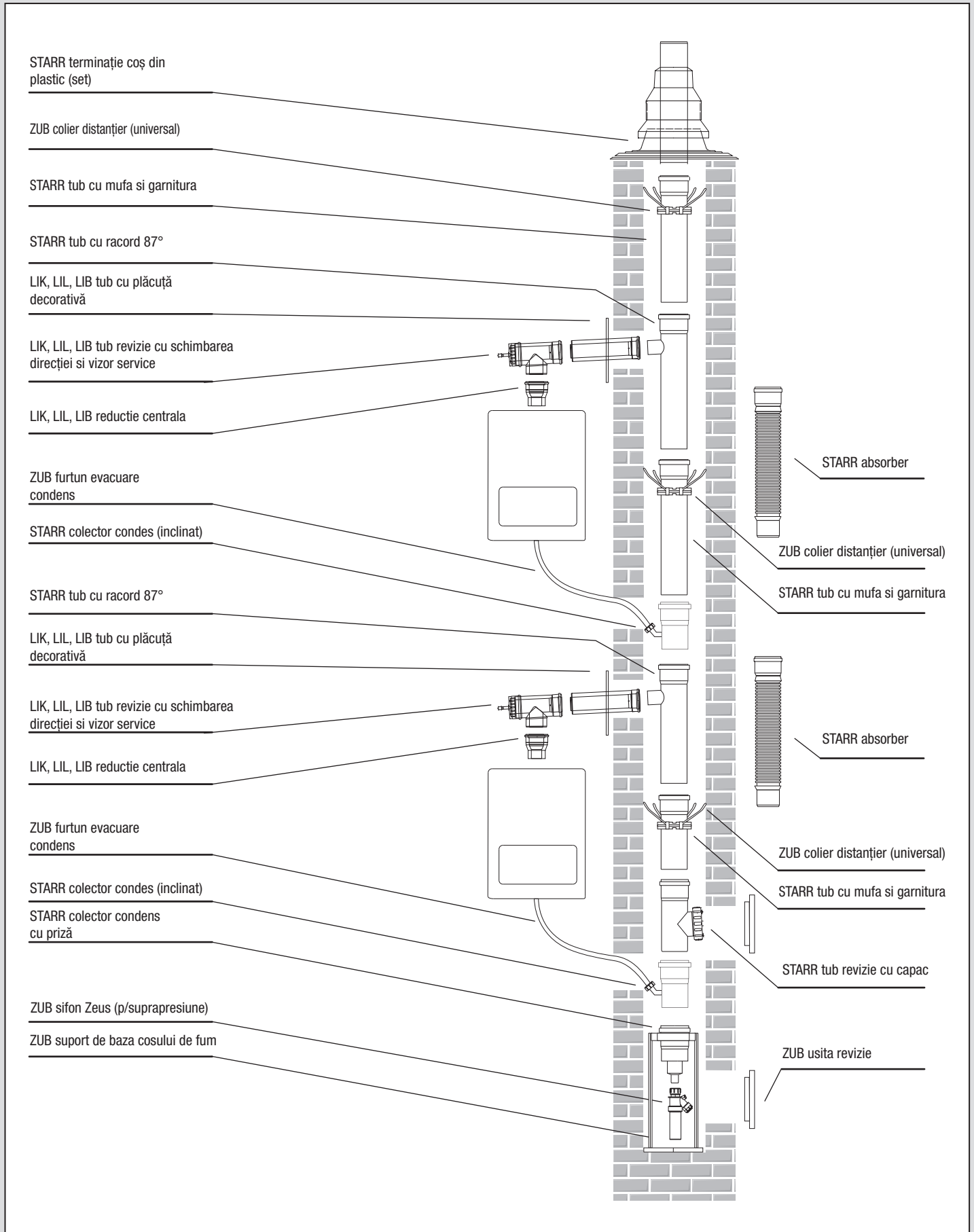

SISTEM DE EVACUARE A GAZELOR ARSE INDEPENDENT DE AERUL DIN ÎNCĂPERE

DN 80 – 315 cu racorduri 87° DN 60 și 80 mm

Varianta 1 (coș plastic instalat în mantale pentru coș sau în canal prevăzut)

LAS
PPH

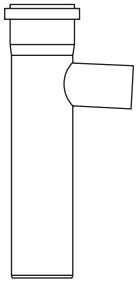
STARR tub cu racord 87°	DN	Cod	Preț [EUR / buc]	Notă
	80 / 60	PBTE58	35,70	
	110 / 60	PBTE51	47,10	
	110 / 80	PBTE81	47,30	
	125 / 60	PBTE52	64,20	
	125 / 80	PBTE82	62,60	
	160 / 60	PBTE56	93,00	
	160 / 80	PBTE86	93,20	
	200 / 60	PBTE50	145,10	
	200 / 80	PBTE80	145,10	
	250 / 60	PBTE5V	174,80	
	250 / 80	PBTE8V	175,00	
	315 / 60	PBTE53	293,40	
	315 / 80	PBTE83	293,80	

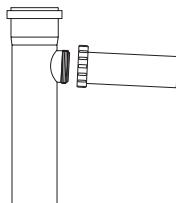
STARR tub racord 87° cu extensie	DN	Cod	Preț [EUR / buc]	Notă
	110 / 60	PBTRL51	65,70	
	110 / 80	PBTRL81	84,60	
	125 / 60	PBTRL52	77,90	
	125 / 80	PBTRL82	96,70	
	160 / 60	PBTRL56	99,50	
	160 / 80	PBTRL86	118,10	
	200 / 60	PBTRL50	141,00	
	200 / 80	PBTRL80	159,50	

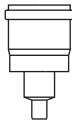
STARR colector condens cu priză	DN	Cod	Preț [EUR / buc]	Notă
	60	PBMA05	16,10	
	80	PBMA08	17,70	
	110	PBMA01	21,00	
	125	PBMA02	31,40	
	160	PBMA06	39,30	
	200	PBMA00	71,20	
	250	PBMA0V	106,30	
	315	PBMA03	107,90	

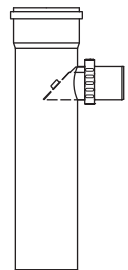
STARR tub racord 87° cu supapa de sens	DN	Cod	Preț [EUR / buc]	Notă	
	110 / 80	PBTK81	135,00		
	125 / 80	PBTK82	149,50		
	160 / 80	PBTK86	175,00		
	200 / 80	PBTK80	228,30		
	250 / 80	PBTK8V	247,70		
	315 / 80	PBTK83	353,40		
	-	-	-	-	
	-	-	-	-	
	-	-	-	-	
	-	-	-	-	

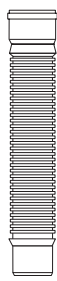
STARR absorber	DN	Cod	Preț [EUR / buc]	Notă	
	80	PBAS58	43,00		
	110	PBAS51	45,70		
	125	PBAS52	64,60		
	160	PBAS56	105,50		
	200	PBAS50	149,30		
	-	-	-	-	
	-	-	-	-	
	-	-	-	-	
	-	-	-	-	
	-	-	-	-	

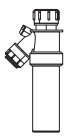
ZUB sifon Zeus (p/suprapresiune M1)	DN	Cod	Preț [EUR / buc]	Notă	
	32 mm	ZUOS32	22,00		
	40 mm	ZUOS40	28,30		
	-	-	-	-	
	-	-	-	-	
	-	-	-	-	
	-	-	-	-	

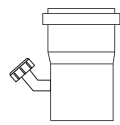
STARR colector condens (inclinat)	DN	Cod	Preț [EUR / buc]	Notă
	60	PBKFS5	43,60	
	80	PBKFS8	44,40	
	110	PBKFS1	48,70	
	125	PBKFS2	54,40	
	160	PBKFS6	60,60	
	200	PBKFS0	84,00	
	250	PBKFSV	117,90	

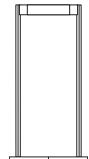
ZUB suport de baza cosului de fum	DN	Cod	Preț [EUR / buc]	Notă
	60	ESTBS5	70,00	
	80	ESTBS8	72,80	
	110	ESTBS1	83,00	
	125	ESTBS2	83,20	
	160	ESTBS6	87,70	
	200	ESTBS0	99,70	

Alte accesorii necesare pentru completarea sistemului LAS (varianta 1) sunt incluse în sistemele STARR, CAS, ZUB. Sistemele LIK, LIL, LIB sunt potrivite pentru conectarea cazanelor la coș comun.

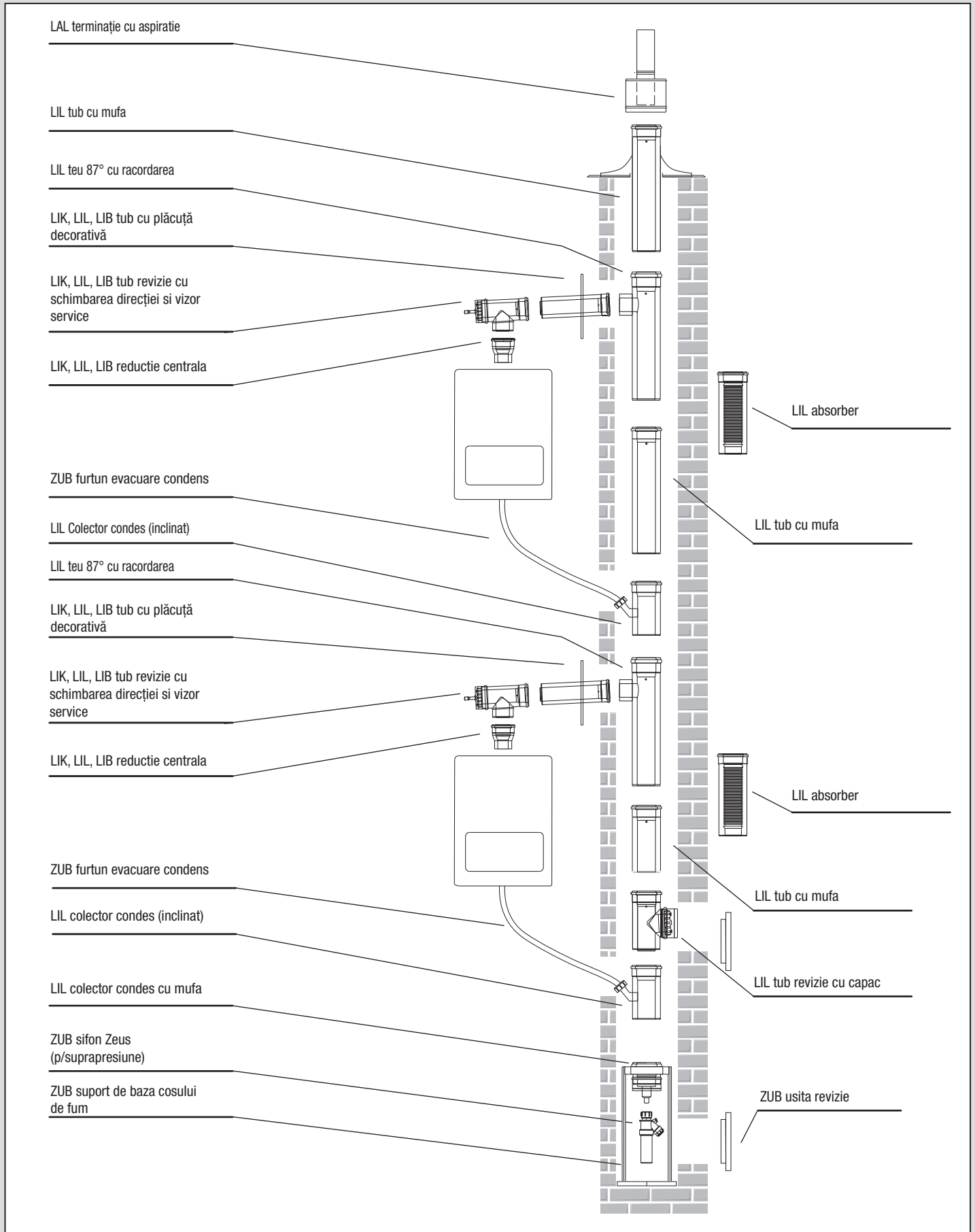

SISTEM DE EVACUARE A GAZELOR ARSE INDEPENDENT DE AERUL DIN ÎNCĂPERE

DN 80 / 125 – 200 / 300 cu racorduri 87° DN 60 / 100 și 80 / 125 mm

Varianta 2 (coș coacsial instalat în canal)

LAS

PPH/inox-komaxit alb

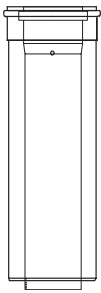
LIL tub cu mufa	DN	Cod	Preț [EUR / buc]	Notă	
	0,25 m	60 / 100	LPRL05	23,80	
		80 / 125	LPRL08	26,90	
		110 / 160	LPRL01	37,30	
		125 / 180	LPRL02	45,00	
		160 / 225	LPRL06	54,40	
		200 / 300	LPRL00	96,70	
0,50 m	60 / 100	LPRL55	34,80		
	80 / 125	LPRL58	37,70		
	110 / 160	LPRL51	52,80		
	125 / 180	LPRL52	63,00		
1,00 m	160 / 225	LPRL56	79,10		
	200 / 300	LPRL50	123,60		
	60 / 100	LPRL15	51,60		
	80 / 125	LPRL18	59,90		
	110 / 160	LPRL11	79,70		
	125 / 180	LPRL12	98,10		
	160 / 225	LPRL16	131,80		
	200 / 300	LPRL10	173,40		

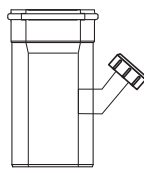
LIL colector condens (inclinat)	DN	Cod	Preț [EUR / buc]	Notă
	80 / 125	LPKLS8	64,20	
	110 / 160	LPKLS1	70,40	
	125 / 180	LPKLS2	79,50	
	160 / 225	LPKLS6	98,50	
	200 / 300	LPKLS0	128,70	
	-	-	-	

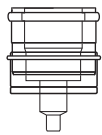
LIL colector condens cu mufa	DN	Cod	Preț [EUR / buc]	Notă
	80 / 125	LPMAL8	36,50	
	110 / 160	LPMAL1	54,60	
	125 / 180	LPMAL2	69,50	
	160 / 225	LPMAL6	81,20	
	200 / 300	LPMAL0	129,90	
	-	-	-	

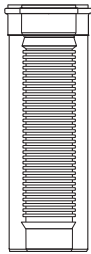
LIL absorber	DN	Cod	Preț [EUR / buc]	Notă
	80 / 125	LPASL8	99,90	
	110 / 160	LPASL1	139,30	
	125 / 180	LPASL2	185,90	
	160 / 225	LPASL6	212,60	
	200 / 300	LPASL0	la cerere	
	-	-	-	
	-	-	-	
	-	-	-	

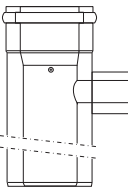
LIL teu 87° cu racord	DN	Cod	Preț [EUR / buc]	Notă	
	1,00 m	Racord 60 / 100			
		80 / 125	LPTEL58	109,30	
		110 / 160	LPTEL51	144,00	
		125 / 180	LPTEL52	154,80	
		160 / 225	LPTEL56	184,60	
	200 / 300	LPTEL50	225,50		
	Racord 80 / 125	110 / 160	LPTEL81	146,70	
		125 / 180	LPTEL82	152,20	
		160 / 225	LPTEL86	184,80	
		200 / 300	LPTEL80	228,70	
-		-	-		

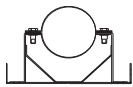
LAL suport p/perete (armat)	DN	Cod	Preț [EUR / buc]	Notă
	80 / 125	APWHL8	56,30	Distanța coșului de la fașada 50 mm
	110 / 160	APWHL1	61,00	
	125 / 180	APWHL2	66,30	
	160 / 225	APWHL6	71,60	
	200 / 300	APWHL0	84,20	

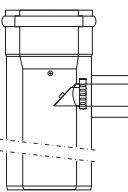
LIL teu 87° cu racord și supapa de sens	DN	Cod	Preț [EUR / buc]	Notă
	1,00 m	Racord 80 / 125		
		110 / 160	LPTKL81	209,50
		125 / 180	LPTKL82	225,90
		160 / 225	LPTKL86	251,80
	Racord 80 / 125	200 / 300	LPTKL80	305,50
		-	-	-
		-	-	-
		-	-	-

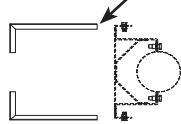
LAL prelungitor suport p/perete (armat)	DN	Cod	Preț [EUR / buc]	Notă
	80 / 125	APVULU	63,20	Distanța coșului de la fașada 50-350 mm
	110 / 160	APVULU	63,20	
	125 / 180	APVULU	63,20	
	160 / 225	APVULU	63,20	
	200 / 300	APVULU	63,20	

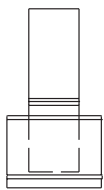
LAL terminație cu aspirație	DN	Cod	Preț [EUR / buc]	Notă
	80 / 125	APMSL8	80,40	
	110 / 160	APMSL1	84,80	
	125 / 180	APMSL2	95,30	
	160 / 225	APMSL6	103,00	
	200 / 300	APMSL0	135,00	
	-	-	-	
	-	-	-	

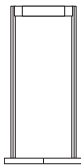
ZUB suport de baza coșului de fum	DN	Cod	Preț [EUR / buc]	Notă
	60 / 100	ESTBSX	78,70	
	80 / 125	ESTBS2	83,20	
	110 / 160	ESTBS6	87,70	
	125 / 180	ESTBSD2	94,20	
	160 / 225	ESTBSD6	107,30	
	200 / 300	ESTBSD0	114,80	
	-	-	-	
	-	-	-	

Alte accesorii necesare pentru finalizarea sistemului LAS (varianta 2) sunt incluse în sistemele LIL, ZUB. Sistemele LIK, LIL, LIB sunt potrivite pentru conectarea cazanelor la coș.

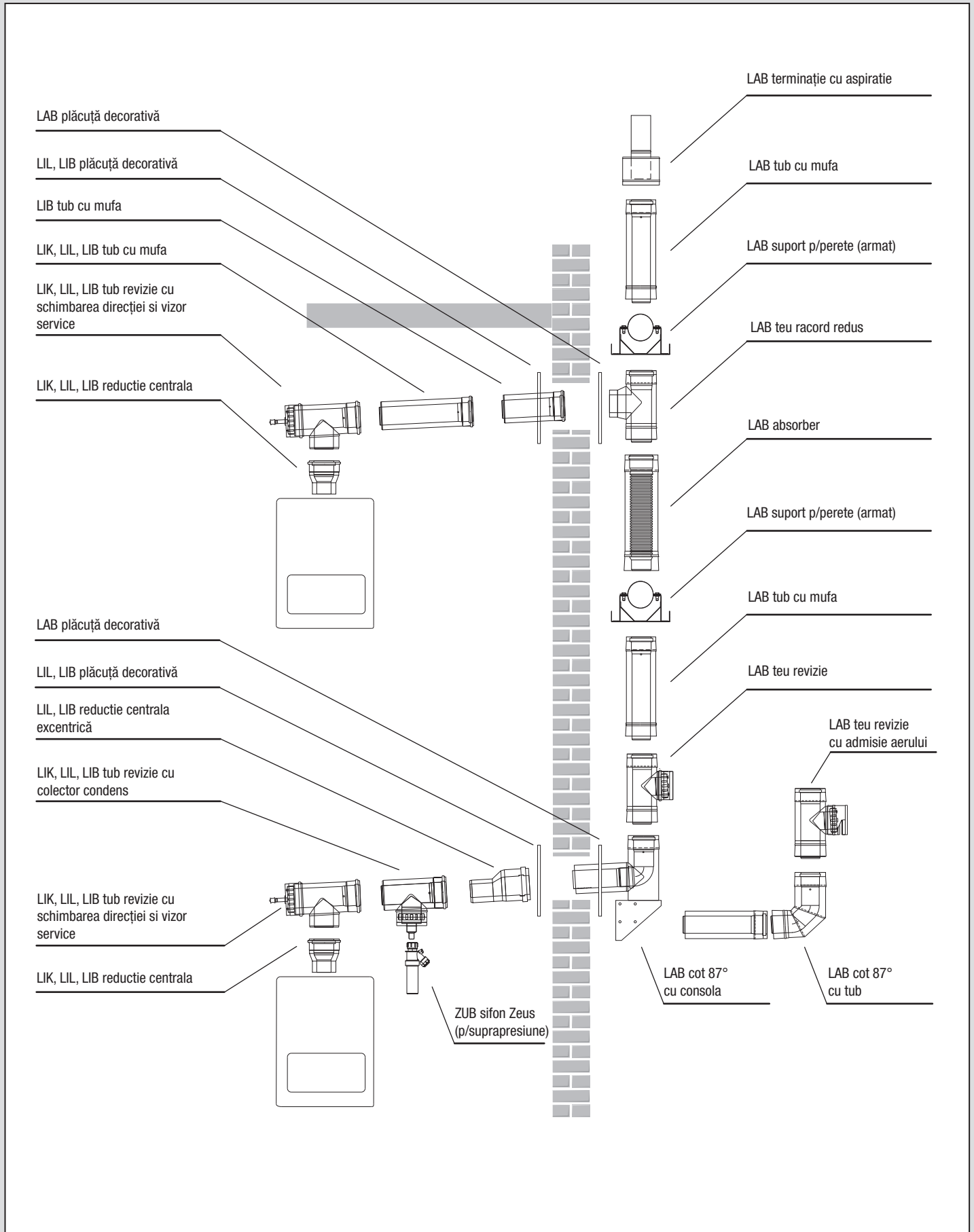

SISTEM DE EVACUARE A GAZELOR ARSE INDEPENDENT DE AERUL DIN ÎNCĂPERE

DN 110 / 160 – 200 / 300 cu racorduri 87° DN 60 / 100 și 80 / 125 mm

Varianta 3 (coș coacsial instalat pe fașada)

LAS
PPH/inox

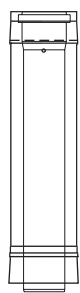
LAB tub cu mufa	DN	Cod	Preț [EUR / buc]	Notă	
	0,25 m	110 / 160	APRB01	32,80	
		125 / 180	APRB02	48,70	
		160 / 225	APRB06	53,80	
		200 / 300	APRB00	91,00	
	0,50 m	110 / 160	APRB51	48,90	
		125 / 180	APRB52	67,10	
		160 / 225	APRB56	77,10	
		200 / 300	APRB50	128,70	
	1,00 m	110 / 160	APRB11	80,60	
		125 / 180	APRB12	110,20	
		160 / 225	APRB16	130,20	
		200 / 300	APRB10	195,70	

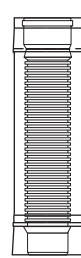
LAB absorber	DN	Cod	Preț [EUR / buc]	Notă
	110/160	APSDB1	133,40	
	125/180	APSDB2	176,50	
	160/225	APSDB6	202,20	
	200/300	APSDB0	231,60	
	-	-	-	
	-	-	-	
	-	-	-	
	-	-	-	
	-	-	-	
	-	-	-	

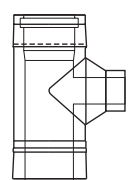
LAB teu racord redus	DN	Cod	Preț [EUR / buc]	Notă	
	racord 60/100	110 / 160	APVB51	148,10	
		125 / 180	APVB52	169,50	
		160 / 225	APVB56	191,80	
		200 / 300	APVB50	236,30	
		-	-	-	
	racord 80/125	110 / 160	APVB81	148,10	
		125 / 180	APVB82	169,50	
		160 / 225	APVB86	191,80	
		200 / 300	APVB80	236,30	
		-	-	-	

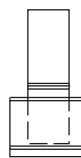
LAL terminație cu aspirație	DN	Cod	Preț [EUR / buc]	Notă
	110 / 160	APMSB1	69,30	
	125 / 180	APMSB2	78,10	
	160 / 225	APMSB6	88,90	
	200 / 300	APMSB0	125,70	
	-	-	-	
	-	-	-	

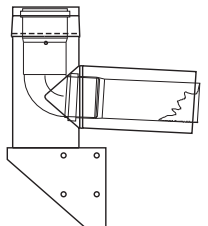
LAB cot 87° cu consola	DN	Cod	Preț [EUR / buc]	Notă	
	110 / 160	APWKB1	169,30	Distanța coșului de la fașada 50 mm	
	125 / 180	APWKB2	184,80		
	160 / 225	APWKB6	218,30		
	200 / 300	APWKB0	355,90		
	-	-	-		
	-	-	-		
	-	-	-		
	-	-	-		

LAB trecerea p/ingustarea tubului	DN	Cod	Preț [EUR / buc]	Notă
	110 / 160	APMKB1	15,10	
	125 / 180	APMKB2	16,90	
	160 / 225	APMKB6	18,30	
	200 / 300	APMKB0	20,80	

LAB cot 87° cu tub	DN	Cod	Preț [EUR / buc]	Notă
	110 / 160	APSBB1	121,80	0,50 m
	125 / 180	APSBB2	155,90	
	160 / 225	APSBB6	188,90	
	200 / 300	APSBB0	295,70	
	-	-	-	

LAB suport p/perete (armat)	DN	Cod	Preț [EUR / buc]	Notă
	110 / 160	APWHB1	50,40	Distanța coșului de la fașada 50 mm
	125 / 180	APWHB2	53,00	
	160 / 225	APWHB6	57,10	
	200 / 300	APWHB0	71,00	
	-	-	-	

LIB tub cu mufa	DN	Cod	Preț [EUR / buc]	Notă	
	0,25 m	60 / 100	LPRB05	26,18	
		80 / 125	LPRB08	29,59	
		-	-	-	
		-	-	-	
		-	-	-	
		-	-	-	
		-	-	-	
		-	-	-	
		-	-	-	
		-	-	-	

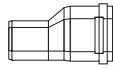
LIL reduție excentrică	DN	Cod	Preț [EUR / buc]	Notă	
	Tub 110/160	60/100	LPKXL51	64,20	
		80/125	LPKXL81	65,70	
		-	-	-	
		-	-	-	
	Tub 125/180	60/100	LPKXL52	74,20	
		80/125	LPKXL82	77,30	
		-	-	-	
		-	-	-	
	Tub 160/225	60/100	LPKXL56	100,20	
		80/125	LPKXL86	101,40	
		-	-	-	
		-	-	-	
	Tub 200/300	60/100	LPKXL50	132,40	
		80/125	LPKXL80	133,80	
		-	-	-	
		-	-	-	

Alte accesorii necesare pentru finalizarea sistemului LAS (varianta 3) sunt incluse în sistemele LAB, ZUB. Sistemele LK, LIL și LIB sunt potrivite pentru conectarea canalului de fum la coș.

Cascade tip Axial

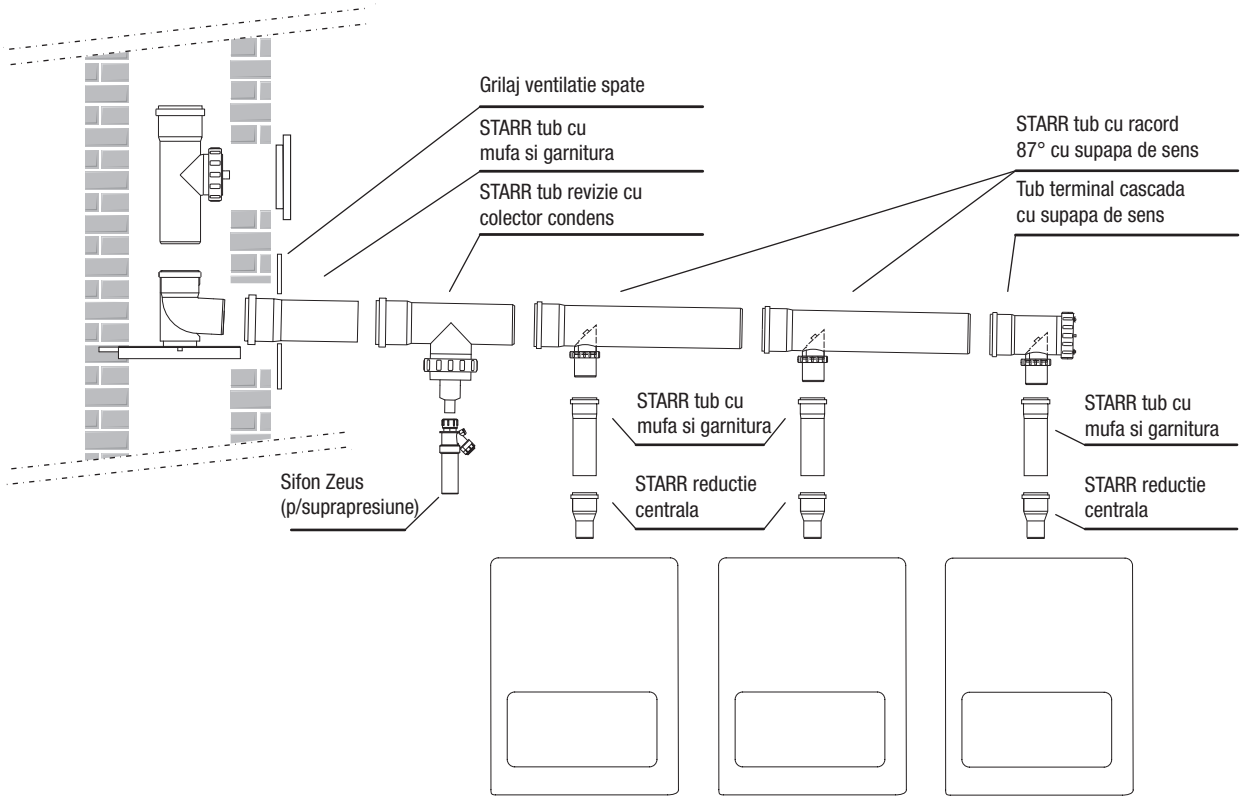

Cascade tip OFFSET

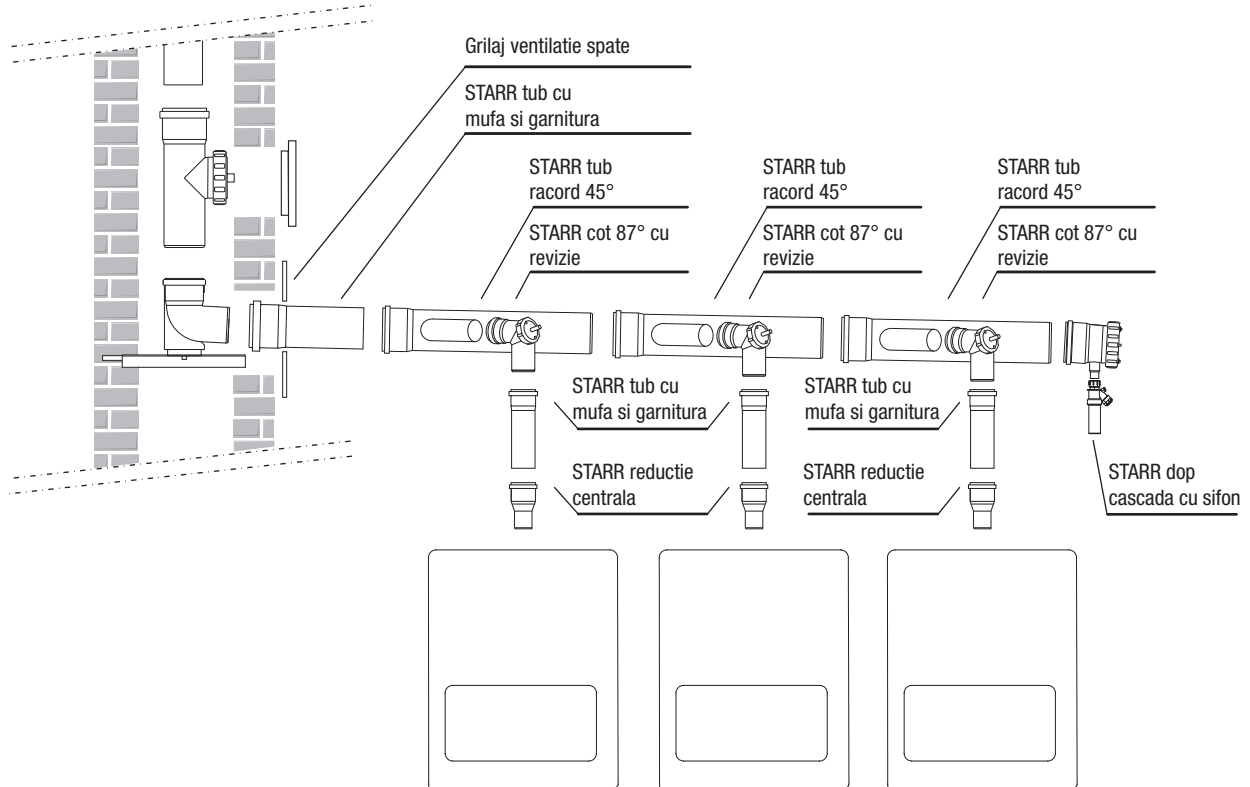

SISTEM DE EVACUARE A GAZELOR ARSE PENTRU CAZANELE RACORDATE ÎN CASCADĂ DN 80 – 315 cu racorduri 45°, 87° DN 60 – 250 mm

Varianta 1 (sistem de cascadă din plastic monostrat)

CAS
PPH

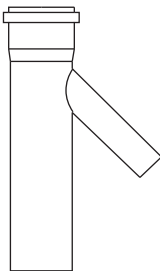
STARR tub racord 45°	DN	Cod	Preț [EUR / buc]	Notă
	110 / 60	PBRK51	51,60	
	110 / 80	PBRK81	52,00	
	125 / 60	PBRK52	69,90	
	125 / 80	PBRK82	69,90	
	125 / 110	PBRK12	71,00	
	160 / 60	PBRK56	100,40	
	160 / 80	PBRK86	100,40	
	160 / 110	PBRK16	101,40	
	160 / 125	PBRK26	105,10	
	200 / 60	PBRK50	155,00	
	200 / 80	PBRK80	155,10	
	200 / 110	PBRK10	156,30	
	200 / 125	PBRK20	159,70	
	200 / 160	PBRK60	164,20	
	250 / 60	PBRK5V	178,10	
	250 / 80	PBRK8V	178,10	
	250 / 110	PBRK1V	178,70	
	250 / 125	PBRK2V	180,60	
	250 / 160	PBRK6V	183,00	
	250 / 200	PBRK0V	186,90	
	315 / 60	PBRK53	293,40	
	315 / 80	PBRK83	293,80	
	315 / 110	PBRK13	299,30	
	315 / 125	PBRK23	306,10	
	315 / 160	PBRK63	310,20	
	315 / 200	PBRK03	306,90	
	315 / 250	PBRKV3	316,90	

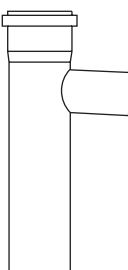
STARR tub cu racord 87°	DN	Cod	Preț [EUR / buc]	Notă
	80 / 60	PBTE58	35,70	
	110 / 60	PBTE51	47,10	
	110 / 80	PBTE81	47,30	
	125 / 60	PBTE52	64,20	
	125 / 80	PBTE82	62,60	
	125 / 110	PBTE12	65,90	
	160 / 60	PBTE56	93,00	
	160 / 80	PBTE86	93,20	
	160 / 110	PBTE16	94,40	
	160 / 125	PBTE26	98,70	
	200 / 60	PBTE50	145,10	
	200 / 80	PBTE80	145,10	
	200 / 110	PBTE10	146,70	
	200 / 125	PBTE20	151,00	
	200 / 160	PBTE60	156,50	
	250 / 60	PBTE5V	174,80	
	250 / 80	PBTE8V	175,00	
	250 / 110	PBTE1V	175,50	
	250 / 125	PBTE2V	178,30	
	250 / 160	PBTE6V	181,00	
	250 / 200	PBTE0V	185,70	
	315 / 60	PBTE53	293,40	
	315 / 80	PBTE83	293,80	
	315 / 110	PBTE13	299,30	
	315 / 125	PBTE23	306,10	
	315 / 160	PBTE63	310,20	
	315 / 200	PBTE03	306,90	
	315 / 250	PBTEV3	316,90	

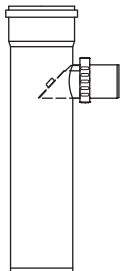
STARR tub racord 87° cu supapa de sens	DN	Cod	Preț [EUR / buc]	Notă
	110 / 80	PBTK81	135,00	
	125 / 80	PBTK82	149,50	
	160 / 80	PBTK86	175,00	
	200 / 80	PBTK80	228,30	
	250 / 80	PBTK8V	247,70	
	315 / 80	PBTK83	353,40	
	160 / 125	PBTK26	228,30	
	200 / 125	PBTK20	282,60	
	250 / 125	PBTK2V	349,90	
	315 / 125	PBTK23	469,30	

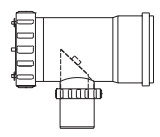
STARR tub terminal cascada cu supapa de sens	DN	Cod	Preț [EUR / buc]	Notă
	80 / 80	PBEK08	130,80	
	110 / 80	PBEK01	162,40	
	125 / 80	PBEK02	179,70	
	160 / 80	PBEK06	221,20	
	200 / 80	PBEK00	297,30	
	250 / 80	PBEK0V	313,40	
	315 / 80	PBEK03	378,50	
	160 / 125	PBEK26	256,30	
	200 / 125	PBEK20	345,90	
	250 / 125	PBEK2V	358,70	
	315 / 125	PBEK23	423,00	

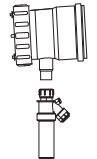
STARR dop cascada cu sifon	DN	Cod	Preț [EUR / buc]	Notă
	110	PBEKA1	84,20	
	125	PBEKA2	99,50	
	160	PBEKA6	120,80	
	200	PBEKA0	149,30	
	250	PBEKAV	175,70	
	315	PBEKA3	219,70	
-	-	-	-	

ZUB supapa de sens	Části klapky	Cod	Preț [EUR / buc]	Notă
	ZK 80	PPSK08	95,30	
	ZK 80	PPAKK8	108,10	cu sifon si dop
	ZK 125	PPSK02	118,70	
	ZK 125	PPAKK2	132,20	cu sifon si dop
	Sifon	PPSS00	10,60	
	Dop	PPKS00	6,50	

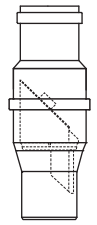
ZUB supapa de sens Multi	DN	Cod	Preț [EUR / buc]	Notă
	110	PBK121	169,50	cu SS 125 incl. sifon
	-	-	-	
	-	-	-	
	-	-	-	
	-	-	-	
	-	-	-	
	-	-	-	
	-	-	-	Doar pentru instalaci în direție verticală

SISTEM DE EVACUARE A GAZELOR ARSE PENTRU CAZANELE RACORDATE ÎN CASCADĂ DN 80 – 315 cu racorduri 45°, 87° DN 60 – 250 mm Varianta 1 (sistem de cascadă din plastic monostrat)

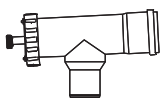
STARR tub revizie redus cu schimbarea direcției și vizor service	DN	Cod	Preț [EUR / buc]	Notă
	80/60	PBKT01	39,30	
	110/60	PBKT051	73,00	
	110/80	PBKT08	71,00	
	125/60	PBKTR52	109,90	
	125/80	PBKT06	113,20	
	125/110	PBKT13	113,80	
	160/80	PBKT61	155,10	
	160/110	PBKT18	155,90	
	160/125	PBKT19	157,90	
	200/80	PBKTR80	239,90	
	200/110	PBKT30	240,60	
	200/125	PBKT35	242,40	
	200/160	PBKT27	230,00	
	250/110	PBKTR1V	274,60	
	250/125	PBKTR2V	275,90	
	250/160	PBKTV2	272,20	
	250/200	PBKTV4	275,00	
	315/110	PBKTR13	420,40	
	315/125	PBKTR23	423,20	
	315/160	PBKTR63	429,10	
315/200	PBKT64	420,60		
315/250	PBKT66	432,80		

Alte dimensiuni la cerere

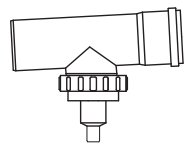
STARR tub revizie cu colector condens	DN	Cod	Preț [EUR / buc]	Notă
	80	PBRTA8	25,00	
	110	PBRTA1	28,50	
	125	PBRTA2	61,00	
	160	PBRTA6	87,10	
	200	PBRTA0	135,10	
	250	PBRTAV	197,70	
315	PBRTA3	215,50		

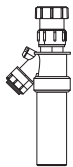
ZUB sifon Zeus (p/suprapresiune M1)	DN	Cod	Preț [EUR / buc]	Notă
	40 mm	ZUOS40	28,30	
	-	-	-	
	-	-	-	
	-	-	-	
	-	-	-	
	-	-	-	
	-	-	-	

Alte accesorii necesare pentru completarea sistemului CAS (varianta 1) sunt incluse în sistemele STARR, ZUB.

SISTEM DE EVACUARE A GAZELOR ARSE PENTRU CAZANELE RACORDATE ÎN CASCADĂ DN 80 – 315 cu racorduri 45°, 87° DN 60 – 250 mm

Varianta 1 (sistem de cascadă din plastic monostrat)

CAS
PPH

Set cascadă AXIAL cu supapa de sens pentru 2 cazane		DN	Cod	Cod set	Preț [EUR / buc]	Notă	
	Supapa de sens DN 80	110 / 80	-	SCMK81B	359,90		
		Conține:					
		110 / 80	PBEK01	STARR tub terminal cascada cu supapa de sens	1x		
		110 / 80	PBTK81	STARR tub racord 87° cu supapa de sens	1x		
		80	PBRM08	STARR tub cu mufa si garnitura 0,25m	2x		
		110	PBRTA1	STARR tub revizie cu colector condens	1x		
		-	ZUOS40	ZUB sifon Zeus (p/suprapresiune M1)	1x		
		-	ZUWK01	ZUB furtun evacuare condens 1m	3x		
		-	ZUSF05	ZUB lubrifiant siliconic 50 g	1x		
		125 / 80	-	SCMK82B	421,00		
		Conține:					
		125 / 80	PBEK02	STARR tub terminal cascada cu supapa de sens	1x		
		125 / 80	PBTK82	STARR tub racord 87° cu supapa de sens	1x		
		80	PBRM08	STARR tub cu mufa si garnitura 0,25m	2x		
		125	PBRTA2	STARR tub revizie cu colector condens	1x		
		-	ZUOS40	ZUB sifon Zeus (p/suprapresiune M1)	1x		
		-	ZUWK01	ZUB furtun evacuare condens 1m	3x		
-	ZUSF05	ZUB lubrifiant siliconic 50 g	1x				
160 / 80	-	SCMK86B	509,50				
Conține:							
160 / 80	PBEK06	STARR tub terminal cascada cu supapa de sens	1x				
160 / 80	PBTK86	STARR tub racord 87° cu supapa de sens	1x				
80	PBRM08	STARR tub cu mufa si garnitura 0,25m	2x				
160	PBRTA6	STARR tub revizie cu colector condens	1x				
-	ZUOS40	ZUB sifon Zeus (p/suprapresiune M1)	1x				
-	ZUWK01	ZUB furtun evacuare condens 1m	3x				
-	ZUSF05	ZUB lubrifiant siliconic 50 g	1x				
	Supapa de sens DN 125	160 / 110	-	SCMK16B	675,00		
		Conține:					
		160 / 125	PBEK26	STARR tub terminal cascada cu supapa de sens	1x		
		160 / 125	PBTK26	STARR tub racord 87° cu supapa de sens	1x		
		110 / 125	PBKA13	STARR reductie centrala - centrică	2x		
		110	PBRM01	STARR tub cu mufa si garnitura 0,25m	2x		
		160	PBRTA6	STARR tub revizie cu colector condens	1x		
		-	ZUOS40	ZUB sifon Zeus (p/suprapresiune M1)	1x		
		-	ZUWK01	ZUB furtun evacuare condens 1m	3x		
		-	ZUSF05	ZUB lubrifiant siliconic 50 g	1x		
		200 / 110	-	SCMK10B	857,30		
		Conține:					
		200 / 125	PBEK20	STARR tub terminal cascada cu supapa de sens	1x		
		200 / 125	PBTK20	STARR tub racord 87° cu supapa de sens	1x		
		110 / 125	PBKA13	STARR reductie centrala - centrică	2x		
		110	PBRM01	STARR tub cu mufa si garnitura 0,25m	2x		
		200	PBRTA0	STARR tub revizie cu colector condens	1x		
-	ZUOS40	ZUB sifon Zeus (p/suprapresiune M1)	1x				
-	ZUWK01	ZUB furtun evacuare condens 1m	3x				
-	ZUSF05	ZUB lubrifiant siliconic 50 g	1x				

Set cascadă AXIAL cu supapa de sens pentru 2 cazane	DN	Cod	Cod set	Preț [EUR / buc]	Notă
	160 / 125	-	SCMK26B	604,60	
	Conține:				
	160 / 125	PBEK26	STARR tub terminal cascada cu supapa de sens		1x
	160 / 125	PBTK26	STARR tub racord 87° cu supapa de sens		1x
	125	PBRM02	STARR tub cu mufa si garnitura 0,25m		2x
	160	PBRTA6	STARR tub revizie cu colector condens		1x
	-	ZUOS40	ZUB sifon Zeus (p/suprapresiune M1)		1x
	-	ZUWK01	ZUB furtun evacuare condens 1m		3x
	-	ZUSF05	ZUB lubrifiant siliconic 50 g		1x
	200 / 125	-	SCMK20B	786,90	
	Conține:				
	200 / 125	PBEK20	STARR tub terminal cascada cu supapa de sens		1x
	200 / 125	PBTK20	STARR tub racord 87° cu supapa de sens		1x
	125	PBRM02	STARR tub cu mufa si garnitura 0,25m		2x
	200	PBRTA0	STARR tub revizie cu colector condens		1x
-	ZUOS40	ZUB sifon Zeus (p/suprapresiune M1)		1x	
-	ZUWK01	ZUB furtun evacuare condens 1m		3x	
-	ZUSF05	ZUB lubrifiant siliconic 50 g		1x	

Set cascadă AXIAL cu supapa de sens pentru cazan adițional	DN	Cod	Cod set	Preț [EUR / buc]	Notă	
	110 / 80	-	SCEK81B	134,80		
	Conține:					
	110 / 80	PBTK81	STARR tub racord 87° cu supapa de sens		1x	
	80	PBRM08	STARR tub cu mufa si garnitura 0,25m		1x	
	125 / 80	-	SCEK82B	148,70		
	Conține:					
	125 / 80	PBTK82	STARR tub racord 87° cu supapa de sens		1x	
	80	PBRM08	STARR tub cu mufa si garnitura 0,25m		1x	
	160 / 80	-	SCEK86B	172,80		
	Conține:					
	160 / 80	PBTK86	STARR tub racord 87° cu supapa de sens		1x	
	80	PBRM08	STARR tub cu mufa si garnitura 0,25m		1x	
		160 / 110	-	SCEK16B	264,40	
		Conține:				
		160 / 125	PBTK26	STARR tub racord 87° cu supapa de sens		1x
		110 / 125	PBKA13	STARR reductie centrala - centrică		1x
110		PBRM01	STARR tub cu mufa si garnitura 0,25m		1x	
200 / 110		-	SCEK10B	315,90		
Conține:						
200 / 125		PBTK20	STARR tub racord 87° cu supapa de sens		1x	
110 / 125	PBKA13	STARR reductie centrala - centrică		1x		
110	PBRM01	STARR tub cu mufa si garnitura 0,25m		1x		
	160 / 125	-	SCEK26B	229,10		
	Conține:					
	160 / 125	PBTK26	STARR tub racord 87° cu supapa de sens		1x	
	125	PBRM02	STARR tub cu mufa si garnitura 0,25m		1x	
	200 / 125	-	SCEK20B	280,60		
	Conține:					
	200 / 125	PBTK20	STARR tub racord 87° cu supapa de sens		1x	
	125	PBRM02	STARR tub cu mufa si garnitura 0,25m		1x	

SISTEM DE EVACUARE A GAZELOR ARSE PENTRU CAZANELE RACORDATE ÎN CASCADĂ DN 80 – 315 cu racorduri 45°, 87° DN 60 – 250 mm

Varianta 1 (sistem de cascadă din plastic monostrat)

CAS
PPH

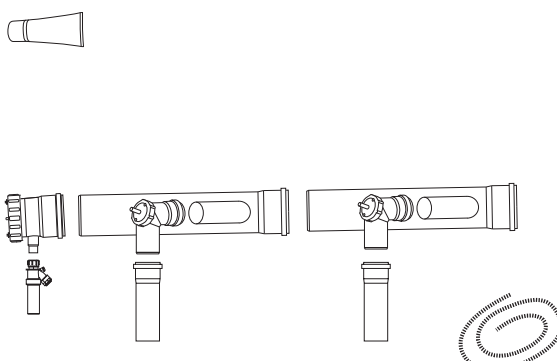
Set cascadă OFFSET fără supapa de sens pentru 2 cazane	DN	Cod	Cod set	Preț [EUR / buc]	Notă
	110 / 80	-	SCMO81B	246,90	
	Conține:				
	110	PBEKA1	STARR dop cascada cu sifon		1x
	110 / 80	PBRK81	STARR tub racord 45°		2x
	80	PBRB98	STARR cot 87° cu revizie		2x
	80	PBRM08	STARR tub cu mufa si garnitura 0,25m		2x
	-	ZUWK01	ZUB furtun evacuare condens 1m		3x
	-	ZUSF05	ZUB lubrifiant siliconic 50 g		1x
	125 / 80	-	SCMO82B	295,30	
	Conține:				
	125	PBEKA2	STARR dop cascada cu sifon		1x
	125 / 80	PBRK82	STARR tub racord 45°		2x
	80	PBRB98	STARR cot 87° cu revizie		2x
	80	PBRM08	STARR tub cu mufa si garnitura 0,25m		2x
	-	ZUWK01	ZUB furtun evacuare condens 1m		3x
	-	ZUSF05	ZUB lubrifiant siliconic 50 g		1x
	160 / 80	-	SCMO86B	373,80	
	Conține:				
	160	PBEKA6	STARR dop cascada cu sifon		1x
	160 / 80	PBRK86	STARR tub racord 45°		2x
	80	PBRB98	STARR cot 87° cu revizie		2x
	80	PBRM08	STARR tub cu mufa si garnitura 0,25m		2x
	-	ZUWK01	ZUB furtun evacuare condens 1m		3x
	-	ZUSF05	ZUB lubrifiant siliconic 50 g		1x
	160 / 110	-	SCMO16B	414,80	
Conține:					
160	PBEKA6	STARR dop cascada cu sifon		1x	
160 / 110	PBRK16	STARR tub racord 45°		2x	
110	PBRB91	STARR cot 87° cu revizie		2x	
110	PBRM01	STARR tub cu mufa si garnitura 0,25m		2x	
-	ZUWK01	ZUB furtun evacuare condens 1m		3x	
-	ZUSF05	ZUB lubrifiant siliconic 50 g		1x	
200 / 110	-	SCMO10B	546,10		
Conține:					
200	PBEKA0	STARR dop cascada cu sifon		1x	
200 / 110	PBRK10	STARR tub racord 45°		2x	
110	PBRB91	STARR cot 87° cu revizie		2x	
110	PBRM01	STARR tub cu mufa si garnitura 0,25m		2x	
-	ZUWK01	ZUB furtun evacuare condens 1m		3x	
-	ZUSF05	ZUB lubrifiant siliconic 50 g		1x	

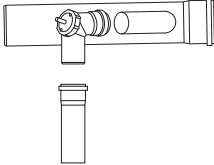
Set cascadă OFFSET fără supapa de sens pentru cazan adițional	DN	Cod	Cod set	Preț [EUR / buc]	Notă
	110 / 80	-	SCE081B	78,30	
	Conține:				
	110 / 80	PBRK81	STARR tub racord 45°		1x
	80	PBRB98	STARR cot 87° cu revizie		1x
	80	PBRM08	STARR tub cu mufa si garnitura 0,25m		1x
	125 / 80	-	SCE082B	95,30	
	Conține:				
	125 / 80	PBRK82	STARR tub racord 45°		1x
	80	PBRB98	STARR cot 87° cu revizie		1x
	80	PBRM08	STARR tub cu mufa si garnitura 0,25m		1x
	160 / 80	-	SCE086B	124,40	
	Conține:				
	160 / 80	PBRK86	STARR tub racord 45°		1x
	80	PBRB98	STARR cot 87° cu revizie		1x
	80	PBRM08	STARR tub cu mufa si garnitura 0,25m		1x
	160 / 110	-	SCEO16B	145,00	
	Conține:				
	160 / 110	PBRK16	STARR tub racord 45°		1x
	110	PBRB91	STARR cot 87° cu revizie		1x
	110	PBRM01	STARR tub cu mufa si garnitura 0,25m		1x
	200 / 110	-	SCEO10B	197,10	
	Conține:				
	200 / 110	PBRK10	STARR tub racord 45°		1x
	110	PBRB91	STARR cot 87° cu revizie		1x
110	PBRM01	STARR tub cu mufa si garnitura 0,25m		1x	

Cascadă concentrică tip AXIAL fără supapa de sens

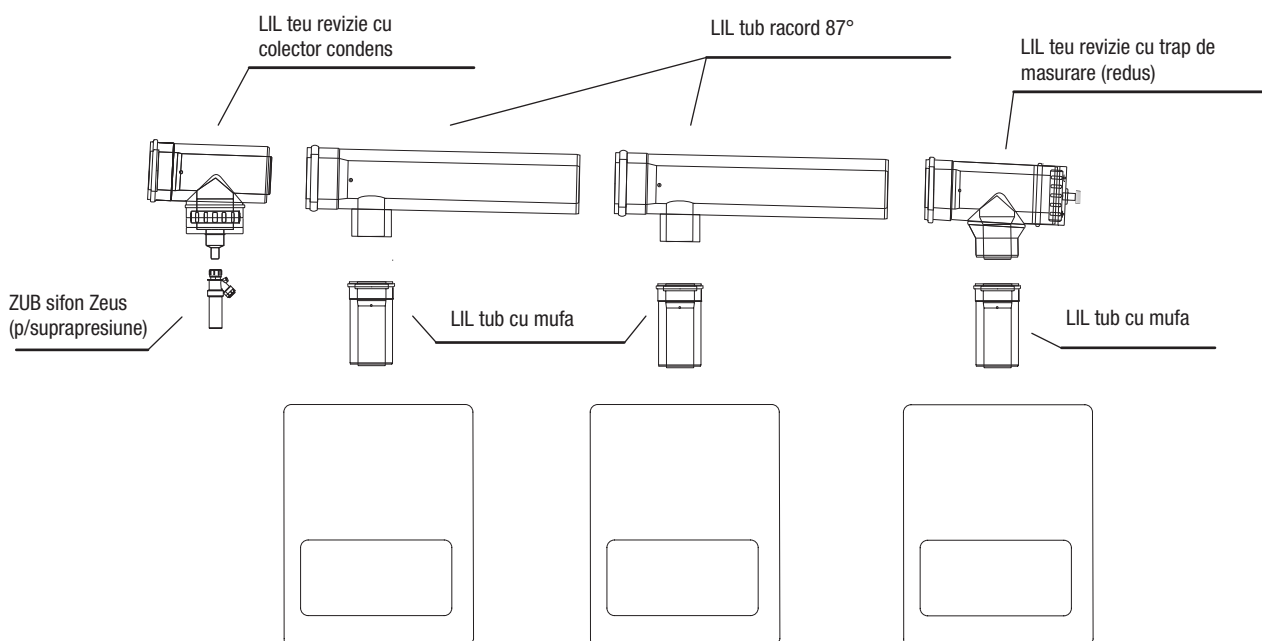

Cascadă concentrică tip AXIAL cu supapa de sens

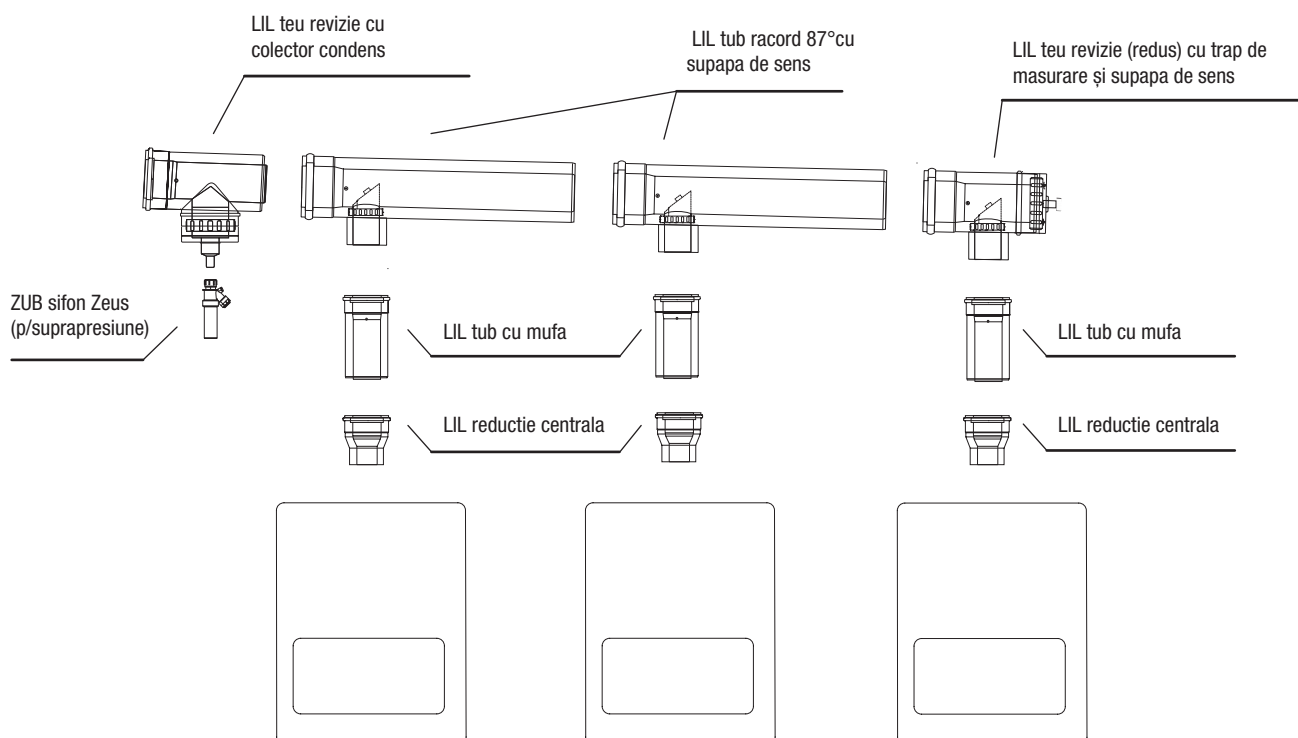

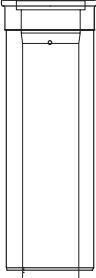
LIL tub cu mufa	DN	Cod	Preț [EUR / buc]	Notă	
	0,25 m	60 / 100	LPRL05	23,80	
		80 / 125	LPRL08	26,90	
		110 / 160	LPRL01	37,30	
		125 / 180	LPRL02	45,00	
		160 / 225	LPRL06	54,40	
		200 / 300	LPRL00	96,70	
	0,50 m	60 / 100	LPRL55	34,80	
		80 / 125	LPRL58	37,70	
		110 / 160	LPRL51	52,80	
		125 / 180	LPRL52	63,00	
		160 / 225	LPRL56	79,10	
		200 / 300	LPRL50	123,60	
	1,00 m	60 / 100	LPRL15	51,60	
		80 / 125	LPRL18	59,90	
		110 / 160	LPRL11	79,70	
		125 / 180	LPRL12	98,10	
		160 / 225	LPRL16	131,80	
		200 / 300	LPRL10	173,40	

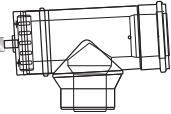
LIL teu revizie redus cu schimbarea direcției și vizor service	DN	Cod	Preț [EUR / buc]	Notă	
 Alte dimensiuni la cerere	Racord 80/125	110 / 160	LPTL12	162,20	
		125 / 180	LPTL22	194,20	
		160 / 225	LPTL60	236,10	
		200 / 300	LPTL00	266,30	
	Racord 110/160	125 / 180	LPTL24	192,00	
		160 / 225	LPTL62	234,00	
		200 / 300	LPTL02	276,70	
		-	-	-	
		-	-	-	
		-	-	-	

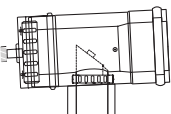
LIL teu revizie (reduc) cu schimbarea direcției și supapa de sens	DN	Cod	Preț [EUR / buc]	Notă	
 Alte dimensiuni la cerere	Racord 80/125	110 / 160	LPEKL81	225,50	
		125 / 180	LPEKL82	261,40	
		160 / 225	LPEKL86	288,90	
		200 / 300	LPEKL80	320,60	
	Racord 125/180	160 / 225	LPEKL26	356,30	
		200 / 300	LPEKL20	394,80	
		-	-	-	
		-	-	-	
		-	-	-	
		-	-	-	

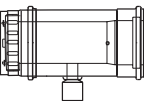
LIL dop cascada cu colector condens	DN	Cod	Preț [EUR / buc]	Notă
	110 / 160	LPEKFL1	128,70	
	125 / 180	LPEKFL2	145,50	
	160 / 225	LPEKFL6	163,60	
	200 / 300	LPEKFL0	229,90	
	-	-	-	

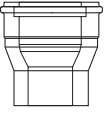
LIL reducere centrala	DN	Cod	Preț [EUR / buc]	Notă	
 Alte dimensiuni la cerere	Tub DN 80 / 125	60 / 100	LPKL01	36,90	
		-	-	-	
		-	-	-	
		-	-	-	
	Tub DN 125 / 180	80 / 125	LPKL22	72,60	
		100 / 150	LPKL23	73,40	
		110 / 160	LPKL24	73,80	
		-	-	-	
		-	-	-	
		-	-	-	

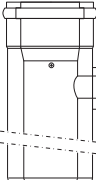
LIL STARR tub racord 87°	DN	Cod	Preț [EUR / buc]	Notă		
 1,00 m	Racord 60 / 100	110 / 160	LPTEL51	144,00		
		125 / 180	LPTEL52	154,80		
		160 / 225	LPTEL56	184,60		
	Racord 80 / 125	110 / 160	LPTEL81	146,70		
		125 / 180	LPTEL82	152,20		
		160 / 225	LPTEL86	184,80		
		200 / 300	LPTEL80	228,70		
		Racord 110 / 160	125 / 180	LPTEL12	167,50	
			160 / 225	LPTEL16	203,40	
	200 / 300		LPTEL10	251,40		
	-		-	-		
	-		-	-		

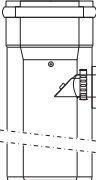
LIL STARR tub racord 87° cu supapa de sens	DN	Cod	Preț [EUR / buc]	Notă	
 1,00 m	Racord 80 / 125	110 / 160	LPTKL81	209,50	
		125 / 180	LPTKL82	225,90	
		160 / 225	LPTKL86	251,80	
	Racord 125 / 180	200 / 300	LPTKL80	305,50	
		160 / 225	LPTKL26	306,50	
		200 / 300	LPTKL20	345,70	
		-	-	-	
		-	-	-	
		-	-	-	
		-	-	-	

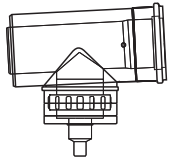
LIL teu revizie cu colector condens	DN	Cod	Preț [EUR / buc]	Notă
	110 / 160	LPRLA1	130,60	
	125 / 180	LPRLA2	147,50	
	160 / 225	LPRLA6	165,70	
	200 / 300	LPRLA0	232,00	
	-	-	-	
	-	-	-	

ZUB sifon Zeus (p/suprapresiune M1)	DN	Cod	Preț [EUR / buc]	Notă
	40 mm	ZUOS40	28,30	
	-	-	-	
	-	-	-	
	-	-	-	
	-	-	-	
	-	-	-	

Alte accesorii necesare pentru finalizarea sistemului CAS (varianta 2) sunt incluse în sistemele LIL, ZUB
Sistemul LIL este potrivit pentru conectarea canalului de fum la coș.

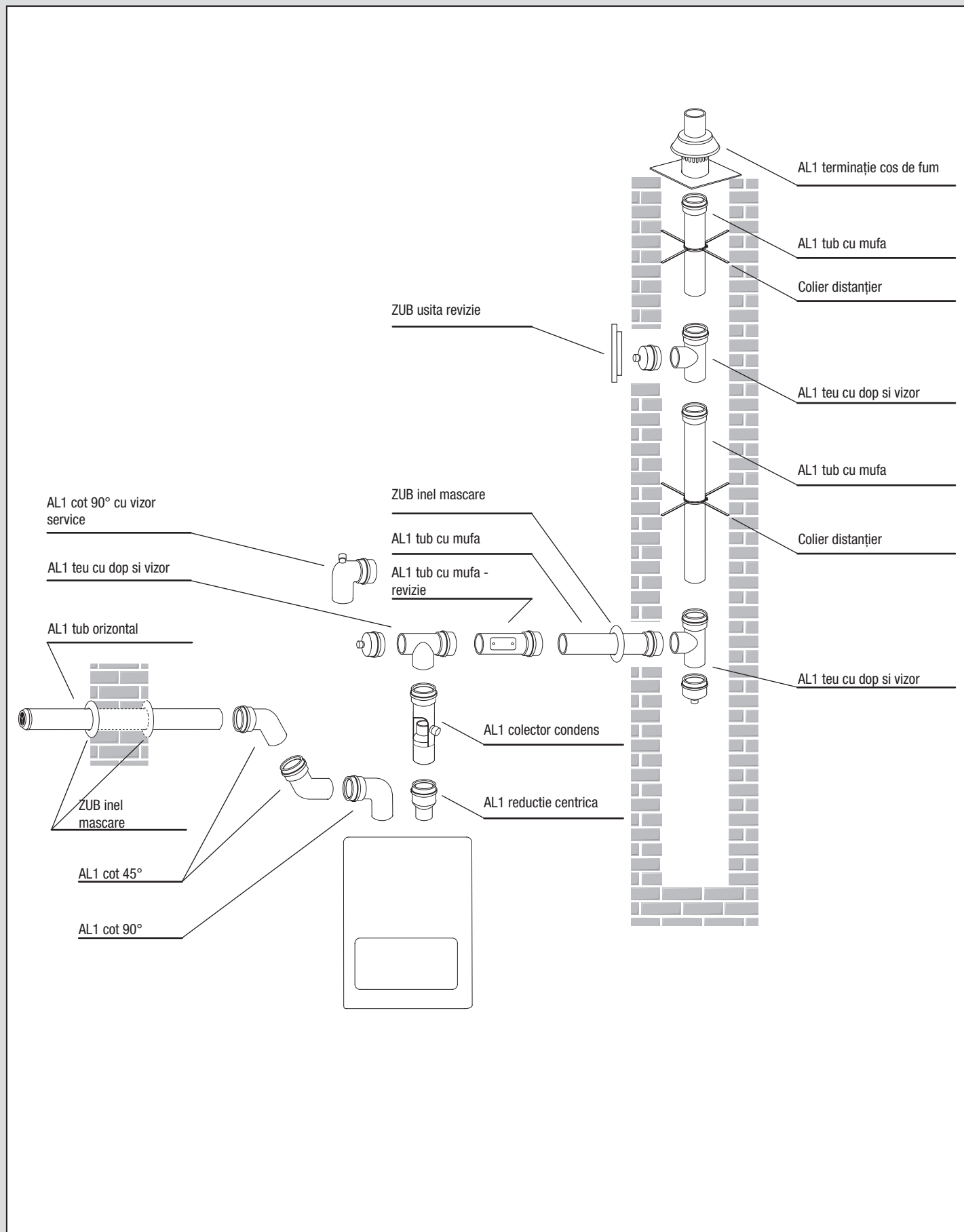

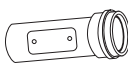

AL1 tub cu mufa	DN	Cod	Preț [EUR / buc]	Notă	
	0,25 m	80	ALRM08	10,80	
		100	ALRM01	14,20	
	0,50 m	60	ANRM55	16,10	nevopsita
		80	ALRM58	15,30	
	1,00 m	100	ALRM51	21,80	
		60	ANRM15	23,00	nevopsita
2,00 m	80	ALRM18	22,60		
	100	ALRM11	30,80		
	80	ALRM28	40,60		
	100	ALRM21	70,60		

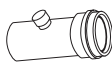
AL1 tub cu mufa - revizie	DN	Cod	Preț [EUR / buc]	Notă	
	0,25 m	80	ALRTD8	51,20	
		100	ALRTD1	55,90	
	-	-	-	-	

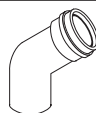
AL1 tub cu vizor service	DN	Cod	Preț [EUR / buc]	Notă	
	0,15 m	80	ALMS08	24,40	
		-	-	-	
		-	-	-	-

AL1 cot 45°	DN	Cod	Preț [EUR / buc]	Notă
	60	ANSB45	21,40	nevopsita
	80	ALSB48	17,70	
	100	ALSB41	26,30	
	-	-	-	-

AL1 cot 90°	DN	Cod	Preț [EUR / buc]	Notă
	60	ANSB95	21,80	nevopsita
	80	ALSB98	14,20	
	100	ALSB91	29,50	
	-	-	-	-

AL1 cot 90° cu revizie	DN	Cod	Preț [EUR / buc]	Notă
	80	ALRB98	46,90	
	100	ALRB91	56,90	
	-	-	-	-

AL1 cot 90° cu vizor service	DN	Cod	Preț [EUR / buc]	Notă
	80	ALSBM8	21,80	
	-	-	-	
	-	-	-	
	-	-	-	

AL1 cot 90°++	DN	Cod	Preț [EUR / buc]	Notă
	80	ALMB98	20,80	
	-	-	-	
	-	-	-	
	-	-	-	

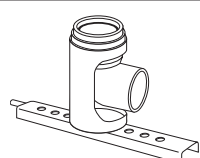
AL1 cot 90° de baza cu suport	DN	Cod	Preț [EUR / buc]	Notă
	80	ANTU08	61,60	nevopsita
	-	-	-	
	-	-	-	
	-	-	-	
	-	-	-	

AL1 teu cu dop si vizor	DN	Cod	Preț [EUR / buc]	Notă
	80/80	ALUTD8	38,90	
	100/100	ALUTD1	81,80	
	-	-	-	
	-	-	-	
	-	-	-	

AL1 teu	DN	Cod	Preț [EUR / buc]	Notă
	80/80	ALTE98	26,50	
	100/100	ALTE91	71,00	
	-	-	-	
	-	-	-	
	-	-	-	

AL1 dop cu vizor	DN	Cod	Preț [EUR / buc]	Notă
	80/80	ALMA08	16,10	
	100/100	ALMA01	21,60	
	-	-	-	
	-	-	-	

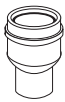
AL1 reductie centrica	DN	Cod	Preț [EUR / buc]	Notă
	60/80	ALKA01	19,50	
	80/100	ALKA02	22,80	
	-	-	-	
	-	-	-	

AL1 colector condens	DN	Cod	Preț [EUR / buc]	Notă
	80	ALKF08	33,80	
	-	-	-	
	-	-	-	
	-	-	-	
	-	-	-	
	-	-	-	

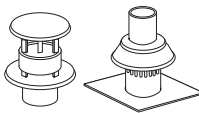
AL1 el, terminal cos de fum	DN	Cod	Preț [EUR / buc]	Notă
	80	ALRS58	47,70	acoperis, negru
	100	ALRS51	54,40	acoperis, negru
	80	ALSAS8	79,10	cu umbrela, negru
	-	-	-	
	-	-	-	

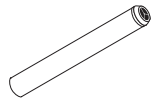
AL1 tub orizontal	DN	Cod	Preț [EUR / buc]	Notă	
	1,00 m	80	ALFSL8	41,40	
		100	ALFSL1	49,70	
		-	-	-	
		-	-	-	
		-	-	-	

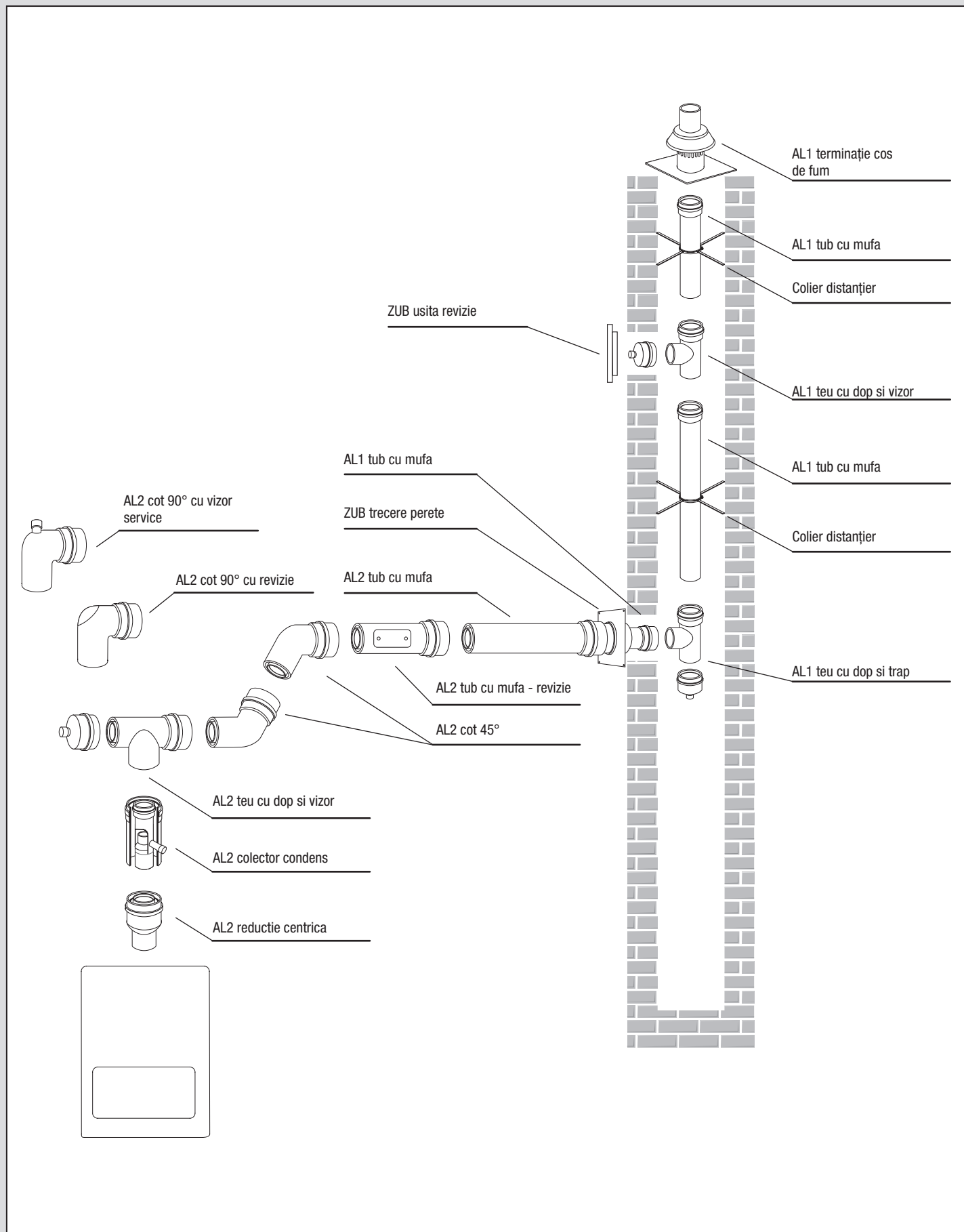

AL2

AL/AL-komaxit alb

SISTEM COȘ DE FUM CONCENTRIC DIN ALUMINIU DN 60 / 100 și 80 / 125 mm

AL2 tub cu mufa	DN	Cod	Preț [EUR / buc]	Notă	
	0,25 m	60 / 100	ALRL05	16,50	
		80 / 125	ALRL08	29,30	
	0,50 m	-	-	-	
		60 / 100	ALRL55	22,00	
		80 / 125	ALRL58	32,00	
	1,00 m	-	-	-	
		60 / 100	ALRL15	31,20	
		80 / 125	ALRL18	41,60	
2,00 m	-	-	-		
	60 / 100	ALRL25	68,30		
	80 / 125	ALRL28	76,90		
-	-	-	-		

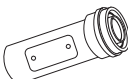
AL2 tub cu mufa - revizie	DN	Cod	Preț [EUR / buc]	Notă	
	0,25 m	60 / 100	ALRTL5	50,40	
		80 / 125	ALRTL8	65,90	
	-	-	-	-	
	-	-	-	-	

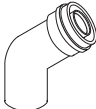
AL2 cot 45°	DN	Cod	Preț [EUR / buc]	Notă
	60 / 100	ALBL45	28,50	
	80 / 125	ALBL48	47,90	
	-	-	-	
	-	-	-	

AL2 cot 90°	DN	Cod	Preț [EUR / buc]	Notă
	60 / 100	ALBL95	28,50	
	80 / 125	ALBL98	48,10	
	-	-	-	
	-	-	-	

AL2 cot 90° cu revizie	DN	Cod	Preț [EUR / buc]	Notă
	60 / 100	ALRLR5	100,60	
	80 / 125	ALRLR8	123,60	
	-	-	-	
	-	-	-	

AL2 cot 90° cu vizor service	DN	Cod	Preț [EUR / buc]	Notă
	60 / 100	ALRLM5	32,80	
	-	-	-	
	-	-	-	
	-	-	-	

ZUB trecere acoperis 25°-45° UNI	DN	Cod	Preț [EUR / buc]	Notă	
	25-45°	60/100 - 80/125	ZUD22S	49,30	neagra
		-	-	-	-
	25-45°	60/100 - 80/125	ZUD22T	49,30	teracota
		-	-	-	-

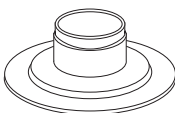
ZUB trecere acoperis - drept	DN	Cod	Preț [EUR / buc]	Notă
	60/100 - 80/125	ALPP35	26,30	Negru, UV stabil
	-	-	-	
	-	-	-	
	-	-	-	
	-	-	-	

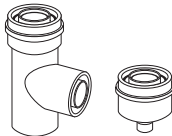
AL2 teu cu dop si vizor	DN	Cod	Preț [EUR / buc]	Notă
	60 / 100	ALUL05	59,30	
	80 / 125	ALUL08	84,40	
	-	-	-	
	-	-	-	
	-	-	-	

AL2 teu	DN	Cod	Preț [EUR / buc]	Notă
	60 / 100	ALVTL5	43,20	
	80 / 125	ALVTL8	70,20	
	-	-	-	
	-	-	-	
	-	-	-	

AL2 dop cu trap	DN	Cod	Preț [EUR / buc]	Notă
	60 / 100	ALMAL5	20,80	
	80 / 125	ALMAL8	20,80	
	-	-	-	
	-	-	-	
	-	-	-	

AL2 reductie centrica (pe 80/125)	DN	Cod	Preț [EUR / buc]	Notă	
	Tub 80 / 125	60 / 100	ALKL01	32,00	
		-	-	-	
		-	-	-	
		-	-	-	

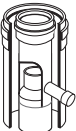
AL2 colector condens	DN	Cod	Preț [EUR / buc]	Notă
	60 / 100	ALKFL5	35,90	Orizontală și verticală
	80 / 125	ALKFL8	44,80	
	-	-	-	
	-	-	-	
	-	-	-	

AL2 tub cu vizori service	DN	Cod	Preț [EUR / buc]	Notă	
	0,11 m	60 / 100	ALMSL5	33,80	Tub interior ++
		80 / 125	ALMSL8	37,50	
		-	-	-	
		-	-	-	
		-	-	-	

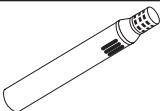
AL2 tub orizontal	DN	Cod	Preț [EUR / buc]	Notă	
	1,00 m	60 / 100	ALASL5	38,50	
		80 / 125	ALASL8	58,10	
		-	-	-	
		-	-	-	

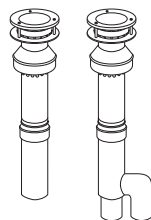
AL2 terminație cos de fum (set)	DN	Cod	Preț [EUR / buc]	Notă	
	1,00 m	60 / 100	ALDS45	134,00	Toate tipurile el. terminale AL2(set) sunt compatibile cu el. terminale ZUD22S, ZUD22T, ALPP35, Neagra.
		80 / 125	ALDS48	130,20	
		80/80	ALDE48	153,60	
		-	-	-	
		-	-	-	
		-	-	-	
		-	-	-	

Sifon Zeus

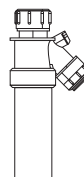

Boxa neutralizare

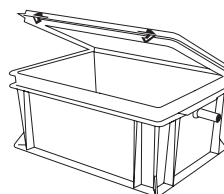

Coș de protecție la admisie



Grilaj

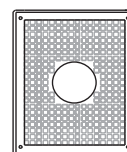

Ușite revizie

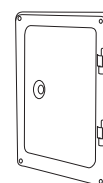

Garnituri etanșare



Lubrifianț siliconic



Materiale pentru fixare

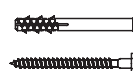

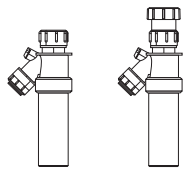
ZUB sifon Zeus (p/suprapresiune M1)	DN	Cod	Preț [EUR / buc]	Notă
	32 mm	ZUOS32	22,00	
	40 mm	ZUOS40	28,30	
	-	-	-	
	-	-	-	
	-	-	-	

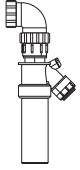
ZUB sifon Zeus 90° (p/suprapresiune)	DN	Cod	Preț [EUR / buc]	Notă
	Priză cu cot 90°	ZUOS94	34,60	
	-	-	-	

ZUB furtun evacuare condens	Lungime	Cod	Preț [EUR / buc]	Notă
	1 bm	ZUWK01	2,80	
	50 bm	ZUWK50	102,60	
	-	-	-	

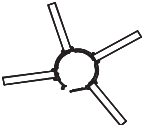
ZUB colier distanțier (universal)	Număr piese	Cod	Preț [EUR / buc]	Notă
	1 pachet	PPFR60	8,50	1 pachet conține 6 segmente/buc Ø 60 – 3 buc Ø 80 – 4 buc Ø 110 – 5 buc Ø 125 – 6 buc Ø 160 – 7 buc Ø 200 – 9 buc
	15 pachet	PPRF15	116,30	
	-	-	-	
	-	-	-	
	-	-	-	
	DN 80	PPFRN8	4,40	

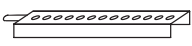
ZUB consola pentru cot de bază	Lungime	Cod	Preț [EUR / buc]	Notă
	390 mm	ZUAS01	14,20	Aluminiu
	390 mm	ZUAS02	14,80	Inox
	750 mm	ZUAS02	31,20	Inox
	-	-	-	
	-	-	-	

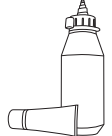

ZUB lubrifianț siliconic	Volum	Cod	Preț [EUR / buc]	Notă
	50 g	ZUSF05	2,80	Pentru cosuri de fum
	250 g	ZUSF25	4,60	Pentru cosuri de fum
	-	-	-	
	-	-	-	
	-	-	-	

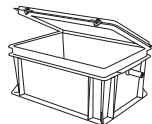
ZUB dop vizor service	Cod	Preț [EUR / buc]	Notă
	EPDM p,1,120°	ZUSTE0	4,80

ZUB boxa neutralizare cu accesorii	Cod	Preț [EUR / buc]	Notă	
	do 120 kW	ZUNF12	121,60	Conține calcar și benzi pentru măsurarea pH-lui
	do 350 kW	ZUNF35	196,70	
	do 1500 kW	ZUNF15	251,20	
	-	-	-	
	-	-	-	

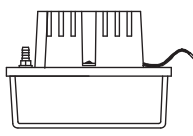
ZUB reful neutralizator	Cod	Preț [EUR / buc]	Notă	
	Calciță 5kg	ZUFM12	13,60	pentru P 120 kW
	Calciță 10kg	ZUFM35	24,80	pentru P 350 kW
	Calciță 25kg	ZUFM15	52,20	pentru P 1500 kW
	Carbon activ	ZUFK12	6,90	pentru P 120 kW
	Carbon activ	ZUFK35	10,80	pentru P 350 kW
	Carbon activ benzi pentru măsurarea pH-ului	ZUFK15	19,30	pentru P 1500 kW
	ZUFS00	4,20	25 buc	

ZUB pompa de evacuare condens	Cod	Preț [EUR / buc]	Notă
		ZUFP00	164,40
	Distanța max. 4,5m		

ZUB coș de aspirație de protecție	DN	Cod	Preț [EUR / buc]	Notă
	80-110	ZUAV52	4,20	Plastic, negru
	-	-	-	
	-	-	-	
	-	-	-	
	80	ALIL08	10,20	Inox (aspirație)
	80	ALIP08	7,30	Plastic (aspirație)
	-	-	-	
	-	-	-	

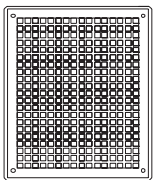
ZUB grilaj ventilatie	Rozmăr [mm]	Cod	Preț [EUR / buc]	Notă
	270x340	ZULG00	46,50	Inox
	150x150	TTLG01	10,80	Aluminiu
	150x300	TTLG02	14,40	
	300x300	TTLG03	24,00	
	150x150	TTLG04	15,30	Inox, antipluvială
	150x300	TTLG05	25,10	

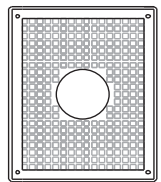
ZUB grilaj ventilatie spate	DN	Cod	Preț [EUR / buc]	Notă
	60	ZUBL05	37,50	
	75	ZUBL07	37,50	
	80	ZUBL08	37,50	
	90	ZUBL09	37,50	
	110	ZUBL01	37,50	
	125	ZUBL02	37,50	
	140	ZUBL04	37,50	
	160	ZUBL06	37,50	
	200	ZUBL00	37,50	
	250	ZUBL0V	37,50	

LISTĂ ACCESORII PENTRU SISTEMELE DIN PLASTIC

ZUB usita revizie	Dimensiune [mm]	Cod	Preț [EUR / buc]	Notă	
	280x410	TTAD01	59,30	Alb	
	280x410	TTAD02	92,80	Inox	
	155x305	TTAD03	29,70	Alb	
	155x305	TTAD04	34,80	Inox	
	-	-	-	-	-
	-	-	-	-	-

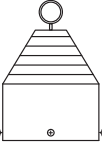
FLEX con evacuare flexibil	DN	Cod	Preț [EUR / buc]	Notă
	60	ZUEZH5	40,40	Frânga nu este furnizată
	80	ZUEZH8	40,60	
	110	ZUEZH1	41,80	
	125	ZUEZH2	43,00	
	160	ZUEZH6	53,80	
	200	ZUEZH0	61,60	

ZUB inel mascare	DN	Cod	Preț [EUR / buc]	Notă
	60	UPRKW4	3,20	Alb
	80	UPRKW7	3,60	Alb
	80	UPRKS7	3,60	Negru, UV stabil
	100	UPRKW5	4,20	Alb
	100	UPRKS5	4,20	Negru, UV stabil
	125	UPRKW8	6,10	Alb
	125	UPRKS8	6,10	Negru, UV stabil

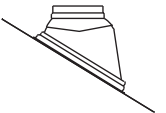
ZUB trecere acoperis 25°-45° UNI	DN	Cod	Preț [EUR / buc]	Notă
	60 / 100 - 80 / 125	ZUD22S	49,30	neagra
		110 / 160	ZUD26S	
	60 / 100 - 80 / 125	ZUD22T	49,30	teracota
		110 / 160	ZUD26T	

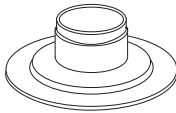
ZUB trecere acoperis - drept	DN	Cod	Preț [EUR / buc]	Notă
	60 / 100 - 80 / 125	ALPP35	26,30	Negru, UV stabil
	-	-	-	-
	-	-	-	-
	-	-	-	-

ZUB „O” - inel pentru vizor service	DN	Cod	Preț [EUR / buc]	Notă
	16	ZUST16	3,20	Material EPDM
	20	ZUST20	3,60	
	40	ZUST40	3,80	
	-	-	-	
	-	-	-	

Garnitura etansare STARR	DN	Cod	Preț [EUR / buc]	Notă
	60	ZUMDE5	2,00	Material EPDM
	80	ZUMDE8	2,20	
	110	ZUMDE1	2,80	
	125	ZUMDE2	3,60	
	160	ZUMDE6	5,10	
	200	ZUMDE0	5,90	
	250	ZUMDEV	14,00	
	315	ZUMDE3	15,70	

ZUB etansare (tubulatura exterioară concentrică)	DN	Cod	Preț [EUR / buc]	Notă
	100	ZULDN5	2,80	LIL, LIB
	125	ZULDN8	3,00	LIL, LIB
	160	ZULDN1	6,30	LIL, LIB
	100	ZULDK5	2,60	LIK
	125	ZULDK8	2,80	LIK
	-	-	-	-



ZUB „O” - inel de etansare	DN	Cod	Preț [EUR / buc]	Notă
	60	ZUORE5	2,40	Material EPDM
	80	ZUORE8	2,60	
	110	ZUORE1	3,00	
	125	ZUORE2	4,80	
	160	ZUORE6	5,50	
	-	-	-	

ZUB inel de siguranță	DN	Cod	Preț [EUR / buc]	Notă
	80	ZUBR08	3,60	Pentru a asigura conexiune cu mufa STARR
	-	-	-	
	-	-	-	
	-	-	-	
	-	-	-	
	-	-	-	

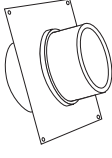
ZUB

ZUB trecere perete	DN	Cod	Preț [EUR / buc]	Notă
	100	ALSAL1	25,70	
	125	ALSAL2	25,70	
	-	-	-	
	-	-	-	
	-	-	-	
	-	-	-	
	-	-	-	

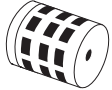
ZUB inel mascare	DN	Cod	Preț [EUR / buc]	Notă
	60	UPRKW4	3,20	Alb
	80	UPRKW7	3,60	Alb
	80	UPRKS7	3,60	Negru, UV stabil
	100	UPRKW5	4,20	Alb
	100	UPRKS5	4,20	Negru, UV stabil
	125	UPRKW8	6,10	Alb
	125	UPRKS8	6,10	Negru, UV stabil

Terminație de protecție	DN	Cod	Preț [EUR / buc]	Notă
	80	ALIN08	11,20	Inox
	100	ALIN01	15,50	Inox
	60 / 100	PPASK5	15,00	Plastic
	-	-	-	
	80	ALIL08	10,20	Inox (aspirație)
	80	ALIP08	7,30	Plastic (aspirație)
	-	-	-	
	-	-	-	

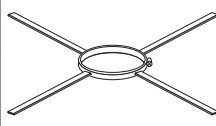
Colier distanțier (universal)	DN	Cod	Preț [EUR / buc]	Notă
	80	ALFR08	8,30	Inox
	100	ALFR01	11,60	Inox
	-	-	-	
	-	-	-	
	-	-	-	

LISTĂ ACCESORII PENTRU SISTEMLILE DIN ALUMINIU

ZUB lubrifiant siliconic	Volum	Cod	Preț [EUR / buc]	Notă
	50 g	ZUSF05	2,80	Pentru cosuri de fum
	250 g	ZUSF25	4,60	Pentru cosuri de fum
	-	-	-	
	-	-	-	
	-	-	-	

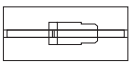
Colier imbinare cu cauciuc	DN	Cod	Preț [EUR / buc]	Notă
	60 / 100	ALKLL5	12,60	
	80 / 125	ALKLL8	13,00	
	-	-	-	

Etansare siliconica	DN	Cod	Preț [EUR / buc]	Notă
	60	ALMDE5	2,60	
	80	ALMDE8	2,80	
	100	ALMDE1	3,80	
	-	-	-	
	-	-	-	
	-	-	-	
	-	-	-	

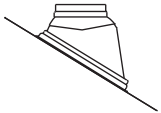
ZUB trecere acoperis 25°-45° UNI	DN	Cod	Preț [EUR / buc]	Notă
	60 / 100 - 80 / 125	ZUD22S	49,30	neagra
	-	-	-	
	60 / 100 - 80 / 125	ZUD22T	49,30	teracota
	-	-	-	

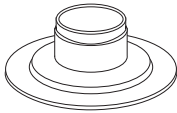
ZUB trecere acoperis - drept	DN	Cod	Preț [EUR / buc]	Notă
	60 / 100 - 80 / 125	ALPP35	26,30	Negru, UV stabil
	-	-	-	
	-	-	-	
	-	-	-	
	-	-	-	

Notă :
Treceri acoperiș sunt compatibile cu toate tipurile de treceri acoperiș AL2 (set).

ACCESORII - PIESE DE ANCORARE

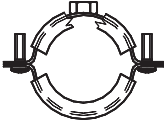
Colier fixare	DN	Cod	Preț [EUR / buc]	Notă
	60	ZOBJ05	1,40	Colier fixare M8/10
	80	ZOBJ08	2,10	Colier fixare M8/10
	100	ZOBJ19	2,40	Colier fixare M8/10
	110	ZOBJ01	2,80	Colier fixare M8/10
	125	ZOBJ02	3,90	Colier fixare M8/10
	160	ZOBJ06	4,40	Colier fixare M8/10
	180	ZOBJ18	4,40	Colier fixare M8/10
	200	ZOBJ00	4,60	Colier fixare M8/10
	225	ZOBJ29	22,90	Colier fixare M12/16
	250	ZOBJ0V	25,10	Colier fixare M12/16
315	ZOBJ03	27,60	Colier fixare M12/16	

Șurub KOMBI	Lungime [mm]	Cod	Preț [EUR / buc]	Notă
	100	ZKMS08	0,20	M8
	140	ZKMS48	0,40	M8
	100	ZKMS10	0,30	M10
	140	ZKMS40	0,40	M10
	140	ZKMS42	0,80	M12

Tija filetată	Lungime [mm]	Cod	Preț [EUR / buc]	Notă
	1000	ZTGV08	1,30	M8
	1000	ZTGV10	2,70	M10
	1000	ZTGV12	4,40	M12
	1000	ZTGV16	8,30	M16

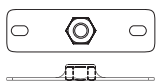
Placută suport	Dimensiune [mm]	Cod	Preț [EUR / buc]	Notă
	80x30	ZPTD08	0,70	M8
	80x30	ZPTD10	0,80	M10
	120x40	ZPTD12	4,00	M12
	120x40	ZPTD16	4,40	M16

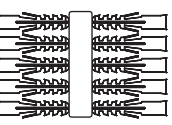
Diblu din plastic	Lungime [mm]	Cod	Preț [EUR / buc]	Notă
	30	ZHMP04	0,30	ø 6mm
	40	ZHMP05	0,40	ø 8mm
	50	ZHMP06	0,50	ø 10mm
	60	ZHMP08	0,60	ø 12mm
	70	ZHMP10	1,60	ø 14mm

Anchor oțel	Lungime [mm]	Cod	Preț [EUR / buc]	Notă
	30	ZKUD08	0,30	M8
	40	ZKUD10	0,40	M10
	50	ZKUD12	1,00	M12
	65	ZKUD16	1,90	M16

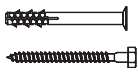
Diblu din plastic + șurub	Lungime [mm]	Cod	Preț [EUR / buc]	Notă
	80	ZHMR08	2,50	Șurub 7mm
	140	ZHMR10	7,80	Șurub 10mm
	-	-	-	-

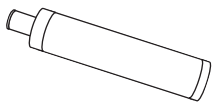
Ancor chimic	Volum [ml]	Cod	Preț [EUR / buc]	Notă
	150 ml	ZCHK00	14,00	
	-	-	-	
	-	-	-	
	-	-	-	

Carcasă din plasă	Lungime [mm]	Cod	Preț [EUR / buc]	Notă
	80	ZPUZ10	1,20	Pentru M8/10
	85	ZPUZ16	4,80	Pentru M12/16
	-	-	-	
	-	-	-	

Piuliță hexagonală	Cod	Preț [EUR / buc]	Notă	
	-	ZMAT06	0,10	M6
	-	ZMAT08	0,10	M8
	-	ZMAT10	0,10	M10
	-	ZMAT12	0,20	M12
	-	ZMAT16	0,40	M16

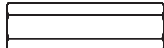
Mafa hexagonală	Cod	Preț [EUR / buc]	Notă	
	-	ZPMA08	0,30	M8
	-	ZPMA10	0,30	M10
	-	ZPMA12	0,70	M12
	-	ZPMA16	1,40	M16
	-	-	-	

Șaibă	Diametru [mm]	Cod	Preț [EUR / buc]	Notă
	6,4	ZPDL06	0,10	
	8,4	ZPDL08	0,10	
	10,5	ZPDL10	0,10	
	13,0	ZPDL12	0,10	
	17,0	ZPDL16	0,20	

Șurub cu cap hexagon	Lungime [mm]	Cod	Preț [EUR / buc]	Notă
	50	ZVRD06	0,10	ø 6mm
	60	ZVRD08	0,20	ø 8mm
	70	ZVRD10	0,40	ø 10mm
	-	-	-	
	-	-	-	

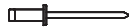
Nituri	Dimensiune [mm]	Cod	Preț [EUR / buc]	Notă
	4,0x8	ZNTA84	0,10	aluminiu - inox
	-	-	-	
	-	-	-	
	-	-	-	
	-	-	-	

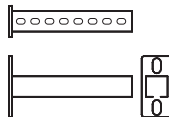
Consola	Dimensiune [mm]	Cod	Preț [EUR / buc]	Notă
	27/18	ZKON31	5,20	300mm
	27/18	ZKON51	6,80	500mm
	38/40	ZKON43	11,20	400mm
	-	-	-	
	-	-	-	

Kit opțional consola	Lungime [mm]	Cod	Preț [EUR / buc]	Notă
	50	ZKSP08	0,80	Pentru 27/18mm
	40	ZKSP12	1,50	Pentru 38/40mm
	-	-	-	
	-	-	-	

INFORMAȚII SUPLIMENTARE

ZERTIFIKAT ◆ CERTIFICATE ◆ CERTIFICADO ◆ CERTIFICAT ◆ 認証証書 ◆ CERTIFICATE ◆ CERTIFIKAT ◆ CERTIFICADO ◆ CERTIFICAT

Notifizierte Stelle
Nr. 0036



Industrie Service

Zertifikat der Konformität der werkseigenen Produktionskontrolle

0036 CPR 9165 001
Revision 02

Gemäß der Verordnung (EU) Nr. 305/2011 des Europäischen Parlaments und des Rates vom 9. März 2011 (Bauproduktenverordnung - CPR) gilt dieses Zertifikat für das Bauprodukt

System-Abgasanlage Typ ALMEVA mit einer Innenschale aus starren Rohren und Formstücken aus PP Ausführungen

ohne Außenschale

Easy ab DN 200	EN 14471	T120 P1 W2 O20 LI E U
Easy bis DN 160	EN 14471	T120 H1 W2 O20 LI E U

mit Kunststoffaußenschale

Double ab DN 200	EN 14471	T120 P1 W2 O00 LI E U1
Double bis DN 160	EN 14471	T120 H1 W2 O00 LI E U1

mit metall. Außenschale

Double LI. ab DN 200	EN 14471	T120 P1 W2 O00 LI E U0
Double LI. bis DN 160	EN 14471	T120 H1 W2 O00 LI E U0
Double LA. ab DN 200	EN 14471	T120 P1 W2 O00 LE E U0
Double LA. bis DN 160	EN 14471	T120 H1 W2 O00 LE E U0

mit mineral. Außenschale

Schacht ab DN 200	EN 14471	T120 P1 W2 O00 LI E U0
Schacht bis DN 160	EN 14471	T120 H1 W2 O00 LI E U0

hergestellt von

Almeva AG
Industriestrasse 6
CH-9220 Bischofszell

im Herstellwerk

Industriestr. 6
CH-9220 Bischofszell

Dieses Zertifikat bescheinigt, dass alle Vorschriften über die Bewertung und Überprüfung der Leistungsbeständigkeit beschrieben im Anhang ZA der harmonisierten Norm

EN 14471:2013+A1:2015

entsprechend System 2+ angewendet werden und dass die werkseigene Produktionskontrolle alle darin vorgeschriebenen Anforderungen erfüllt.

Die Feststellung des Produkt-Typs anhand einer Typprüfung ist dokumentiert im Bericht: TÜV SÜD Industrie Service GmbH, A 1661-01/08 und A 1661-02/16.

Dieses Zertifikat wurde erstmals am 2008-03-15 ausgestellt und bleibt gültig, solange sich die in der harmonisierten Norm genannten Prüfverfahren und/oder Anforderungen der werkseigenen Produktionskontrolle zur Bewertung der Leistung der erklärten Merkmale nicht ändern und das Produkt und die Herstellbedingungen im Werk nicht wesentlich geändert werden.

München, 2016-07-06

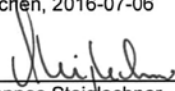
Johannes Steiglechner
Leiter Zertifizierungsgestelle Bauprodukte (EG)

TÜV SÜD INDUSTRIE SERVICE GMBH, WESTENDSTRASSE 199, 80686 MÜNCHEN

TÜV®

INFORMAȚII SUPLIMENTARE

Declarații de performanță



Etichete cu date tehnice coșuri de fum



INFORMAȚII SUPLIMENTARE

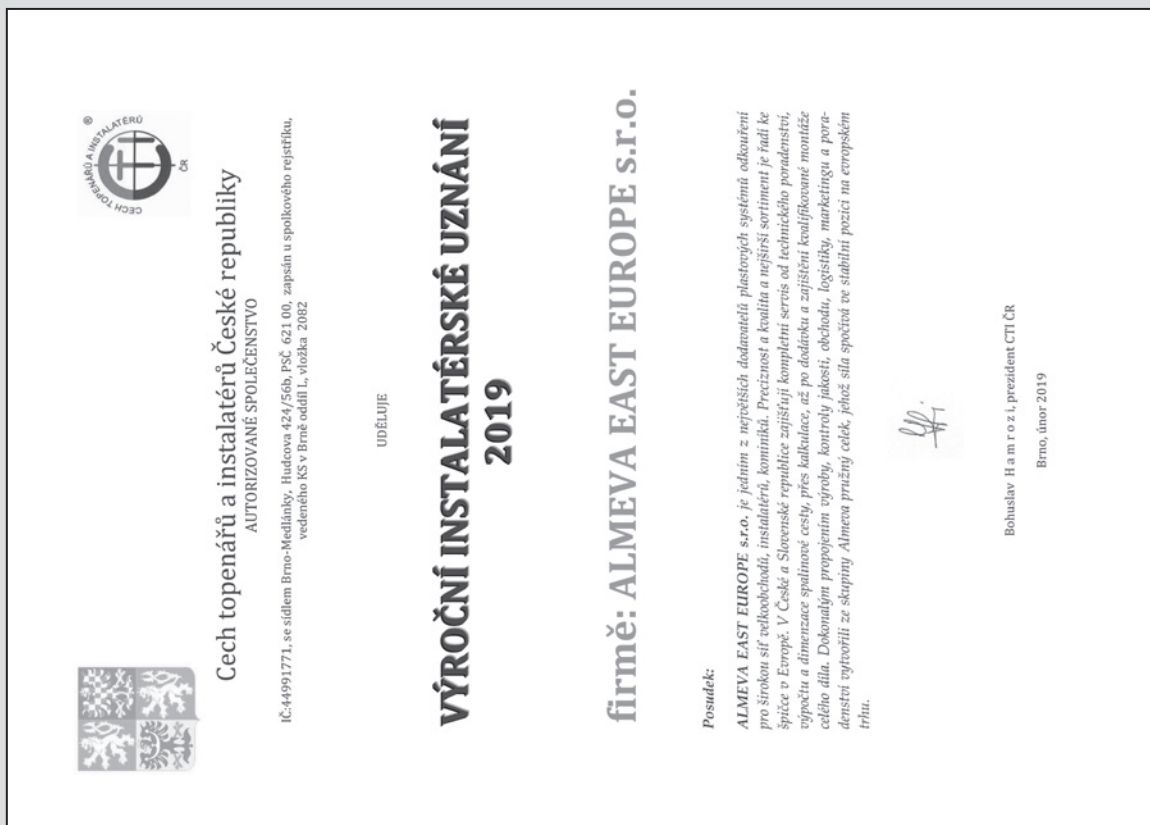

INFORMAȚII SUPLIMENTARE



Proiectat
în Elveția



Mai mult de 9000
de elemente de coș de fum



3000 de articole
în stoc



Suport tehnic
profesionist



Certificat de calitate al Camerei
de Comerț a Republicii Cehe

Găsiți reprezentantul dumneavoastră comercial

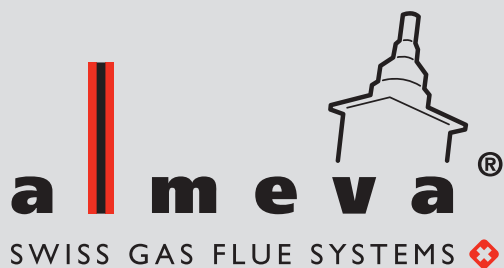

almeva în România & R.Moldova

ALMEVA EAST EUROPE a.s.

Družstevní 501

CZ-664 43 Želešice

Czech Republic

Tel.: +40 312 296 088

+373 692 355 25

E-mail: igor.ursu@almeva.ro

Sisteme de coșuri din plastic și aluminiu
pentru evacuare a gazelor arse

www.almeva.ro
www.almeva.md